

 Anfitec



VISSERIE
BOULONNERIE

Édition 2020







MARQUES
EXCLUSIVES
RUBIX

EFFICACITÉ. DISPONIBILITÉ. FIABILITÉ





Sommaire





	<u>Visserie-boulonnerie acier zingué</u>	6
	<u>Visserie-boulonnerie passivé jaune</u>	26
	<u>Visserie-boulonnerie acier brut</u>	27
	<u>Visserie-boulonnerie inox A2</u>	43
	<u>Visserie-boulonnerie inox A4</u>	66
	<u>Visserie-boulonnerie nylon</u>	71
	<u>Visserie-boulonnerie laiton</u>	71



Une gamme dédiée

Anfitec est la Marque Exclusive Rubix en boulonnerie-visserie. Elle répond à l'ensemble de vos besoins standards en maintenance industrielle. Elle est composée de 5 000 références produits dont plus de 2 000 en stock pour des livraisons à délais courts.

Anfitec, c'est :

-  Une offre d'assemblage qui couvre l'ensemble des domaines de l'industrie : boulonnerie, visserie, écrous, tiges filetées, circlips.
-  Des matières disponibles en acier brut, zingué, inox A2, inox A4, PA6, laiton.
-  Des dimensions spécifiques disponibles hors catalogue.
-  Des compléments de gammes GISS : coffrets, colliers, chevilles, rivets, goujons d'ancrage et de la fixation chimique.
-  Une réponse aux normes en vigueur et une qualité certifiée répondant à un contrôle strict et aux exigences de l'industrie.

Trouvez facilement vos produits grâce aux pictogrammes de matières et de normes





Scannez & commandez !

Facilitez votre réassort
et gagnez du temps avec
notre application mobile Rubix.



1

Je **contacte** mon
agence de proximité.

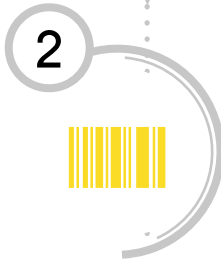

2

Je **commande**
mes étiquettes.



3

Je **scanne** mes articles avec
notre application mobile Rubix.



4

Je **valide**
mon panier !



DISPONIBLE SUR
 Google Play

 Télécharger dans
l'App Store



Organisez votre magasin !

Implantez votre visserie
grâce à nos solutions
d'aménagement **GISS**.



Rayonnage à tablettes tôlees spécial visserie :

Kit de deux mètres de haut composé
de onze tablettes dont neuf inclinées
avec séparateurs et butées de façade.
Solution idéale pour le rangement
des boîtes de boulonnerie, visserie,
chevilles, etc.



Bacs à bec en polyéthylène haute densité très rigide :

Disponibles en sept dimensions
et quatre coloris.

Retrouvez tous nos produits dans
notre catalogue **Marques Exclusives**



Pour un devis, contactez votre agence
par téléphone, courrier ou mail.





ÉCROU HEXAGONAL 6 PANS 8.8

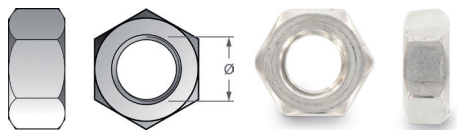

Ø (mm)	Clé	Boîlage	Code	Référence
4	7	250	ECHU4.8Z	V600-8204160
5	8	250	ECHU5.8Z	V600-8204159
6	10	250	ECHU6.8Z	V600-8204158
7	11	250	ECHU7.8Z	V600-8204157
8	13	250	ECHU8.8Z	V600-8204156
10	17	250	ECHU10.8Z	V600-8204155
10	16	250	ECHU10.8ZISO	V600-8204154
12	19	100	ECHU12.8Z	V600-8204153
12	18	100	ECHU12.8ZISO	V600-8204152
14	22	100	ECHU14.8Z	V600-8204151

Ø (mm)	Clé	Boîlage	Code	Référence
14	21	100	ECHU14.8ZISO	V600-8204150
16	24	100	ECHU16.8Z	V600-8204149
18	27	50	ECHU18.8Z	V600-8204148
20	30	50	ECHU20.8Z	V600-8204147
22	32	25	ECHU22.8Z	V600-8204146
22	34	25	ECHU22.8ZISO	V600-8204145
24	36	25	ECHU24.8Z	V600-8204144
27	41	10	ECHU27.8Z	V600-8204143
30	46	10	ECHU30.8Z	V600-8204142
33	50	5	ECHU33.8Z	V600-8208803

Autres dimensions disponibles sur demande.



ÉCROU À OREILLES



Ø (mm)	Boîlage	Code	Référence
3	250	ECOR3Z	V600-8204187
4	250	ECOR4Z	V600-8204186
5	250	ECOR5Z	V600-8204188
6	250	ECOR6Z	V600-8204185

Ø (mm)	Boîlage	Code	Référence
8	100	ECOR8Z	V600-8204184
10	100	ECOR10Z	V600-8204183
12	50	ECOR12Z	V600-8204182

Autres dimensions disponibles sur demande.



ÉCROU BORGNE

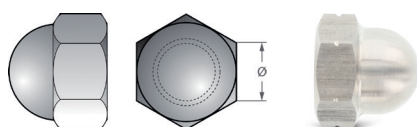

Ø (mm)	Clé	Boîlage	Code	Référence
3	5,5	250	ECHR3Z	V600-8204181
4	7	250	ECHR4Z	V600-8204180
5	8	250	ECHR5Z	V600-8204178
6	10	250	ECHR6Z	V600-8204179

Ø (mm)	Clé	Boîlage	Code	Référence
8	13	250	ECHR8Z	V600-8204177
10	17	200	ECHR10Z	V600-8204176
12	19	100	ECHR12Z	V600-8204175
14	22	50	ECHR14Z	V600-8204174

Autres dimensions disponibles sur demande.



ÉCROU À ENFONCER POUR BOIS ACIER ZINGUÉ

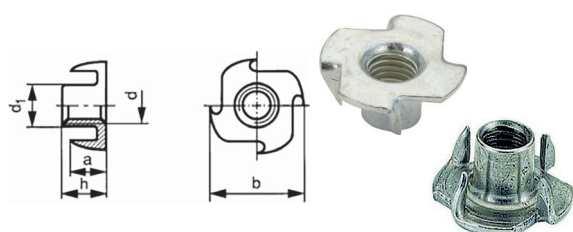

Ø (mm)	Boîlage	Code	Référence
5	500	ECHUGRIF5Z	V600-8205761

ÉCROU FREIN BAGUE

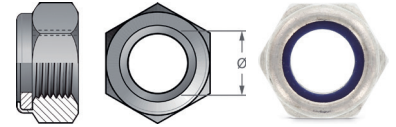

Ø (mm)	Clé	Boîlage	Code	Référence
3	5.5	250	ECF3.8Z	V600-8204173
4	7	250	ECF4.8Z	V600-8204172
5	8	250	ECF5.8Z	V600-8204171
6	10	250	ECF6.8Z	V600-8204170
8	13	250	ECF8.8Z	V600-8204169
10	17	200	ECF10.8Z	V600-8204168
12	19	100	ECF12.8Z	V600-8204167
14	22	100	ECF14.8Z	V600-8204166

Ø (mm)	Clé	Boîlage	Code	Référence
16	24	50	ECF16.8Z	V600-8204165
18	27	50	ECF18.8Z	V600-8204163
20	30	25	ECF20.8Z	V600-8204162
22	32	25	ECF22.8Z	V600-8204161
24	36	25	ECF24.8Z	V600-8204164
27		10	ECF27.8Z	V600-8205778
30		10	ECF30.8Z	V600-8205777

Autres dimensions disponibles sur demande.

RONDELLE PLATE ÉTROITE

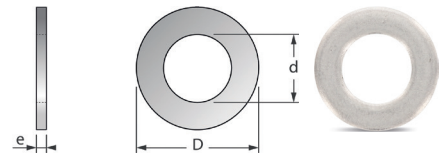

Ø	Dimensions (mm)	Boîlage	Code	Référence
Z3	3,2x6x0,8	500	RONZ3Z	V600-8204015
Z4	4,3x8x0,8	500	RONZ4Z	V600-8204014
Z5	5,3x10x1	500	RONZ5Z	V600-8204013
Z6	6,4x12x1,2	250	RONZ6Z	V600-8204012
Z8	8,4x16x1,5	250	RONZ8Z	V600-8204011
Z10	10,5x20x2	200	RONZ10Z	V600-8204010
Z12	13x24x2,5	150	RONZ12Z	V600-8204008
Z14	15x27x2,5	100	RONZ14Z	V600-8204007

Ø	Dimensions (mm)	Boîlage	Code	Référence
Z16	17x30x3	100	RONZ16Z	V600-8204006
Z18	19x32x3	100	RONZ18Z	V600-8204005
Z20	21x36x3	100	RONZ20Z	V600-8204004
Z22	23x40x3	100	RONZ22Z	V600-8205425
Z24	25x45x4	100	RONZ24Z	V600-8204003
Z27	28x48x4	100	RONZ27Z	V600-8205424
Z30	31x52x4	100	RONZ30Z	V600-8205423

Autres dimensions disponibles sur demande.

RONDELLE PLATE MOYENNE

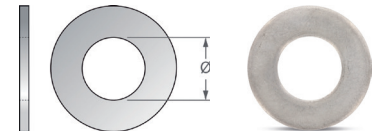

Ø	Dimensions (mm)	Boîlage	Code	Référence
M3	3,2x8x0,8	500	RONMU3Z	V600-8203977
M4	4,3x10x0,8	500	RONMU4Z	V600-8203976
M5	5,3x12x1	500	RONMU5Z	V600-8203975
M6	6,4x14x1,2	500	RONMU6Z	V600-8203974
M7	7,4x16x1,5	250	RONMU7Z	V600-8203973
M8	8,4x18x1,5	250	RONMU8Z	V600-8203972
M10	10,5x22x2	200	RONMU10Z	V600-8203971
M12	13x27x2,5	200	RONMU12Z	V600-8203970
M14	15x30x2,5	200	RONMU14Z	V600-8203969
M16	17x32x3	100	RONMU16Z	V600-8203968

Ø	Dimensions (mm)	Boîlage	Code	Référence
M18	19x36x3	100	RONMU18Z	V600-8203967
M20	21x40x3	100	RONMU20Z	V600-8203966
M22	23x45x3	100	RONMU22Z	V600-8203965
M24	25x50x4	100	RONMU24Z	V600-8203964
M27	28x55x4	100	RONMU27Z	V600-8203963
M30	31x60x4	100	RONMU30Z	V600-8203962
M33	34x65x5	100	RONMU33Z	V600-8205403
M36	37x70x5	100	RONMU36Z	V600-8205402
M39	40x75x6	100	RONMU39Z	V600-8205401
M42	43x80x6	100	RONMU42Z	V600-8205400

Autres dimensions disponibles sur demande.

RONDELLE PLATE LARGE

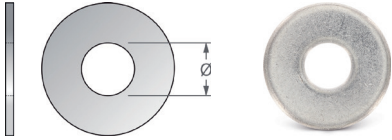

Ø	Dimensions (mm)	Boîtage	Code	Référence
L3	3,2x12x0,8	500	RONLU3Z	V600-8203989
L4	4,3x14x0,8	500	RONLU4Z	V600-8203988
L5	5,3x16x1	500	RONLU5Z	V600-8203987
L6	6,4x18x1,2	500	RONLU6Z	V600-8203986
L7	7,4x20x1,5	250	RONLU7Z	V600-8203985
L8	8,4x22x1,5	250	RONLU8Z	V600-8203984
L10	10,5x27x2	200	RONLU10Z	V600-8203983
L12	13x32x2,5	200	RONLU12Z	V600-8203982

Ø	Dimensions (mm)	Boîtage	Code	Référence
L14	15x36x2,5	200	RONLU14Z	V600-8203981
L16	17x40x3	100	RONLU16Z	V600-8203980
L18	19x45x3	100	RONLU18Z	V600-8203979
L20	21x50x3	100	RONLU20Z	V600-8203978
M22	23x55x3	100	RONLU22Z	V600-8205391
M24	25x60x4	100	RONLU24Z	V600-8205390
M27	28x65x4	100	RONLU27Z	V600-8205389
M30	31x70x4	100	RONLU30Z	V600-8205388

Autres dimensions disponibles sur demande.

RONDELLE PLATE EXTRA LARGE

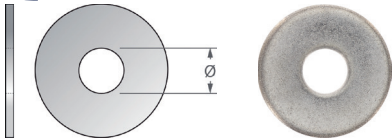

Ø (mm)	Dimensions (mm)	Boîtage	Code	Référence
LL3	3,2x14x0,8	500	RONLLU3Z	V600-8204002
LL4	4,3x16x0,8	500	RONLLU4Z	V600-8204000
LL5	5,3x20x1	500	RONLLU5Z	V600-8203999
LL6	6,4x24x1,2	250	RONLLU6Z	V600-8203998
LL7	7,4x27x1,5	250	RONLLU7Z	V600-8203997
LL8	8,4x30x1,5	250	RONLLU8Z	V600-8203996
LL10	10,5x36x2	200	RONLLU10Z	V600-8203995
LL12	13x40x2,5	200	RONLLU12Z	V600-8203994

Ø (mm)	Dimensions (mm)	Boîtage	Code	Référence
LL14	15x45x2,5	100	RONLLU14Z	V600-8203993
LL16	17x50x3	100	RONLLU16Z	V600-8203992
LL18	19x55x3	100	RONLLU18Z	V600-8203991
LL20	21x60x3	100	RONLLU20Z	V600-8203990
M22	23x65x3	100	RONLLU22Z	V600-8205387
M24	25x70x4	100	RONLLU24Z	V600-8205386
M27	28x78x4	100	RONLLU27Z	V600-8205385

Autres dimensions disponibles sur demande.

RONDELLE PLATE

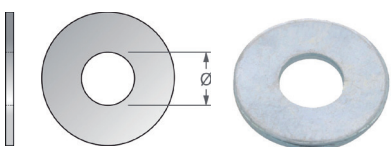

Ø (mm)	Dimensions (mm)	Boîtage	Code	Référence
M4	4,3x12x1	250	RONPLU4Z	V600-8205384
M5	5,3x15x1,2	250	RONPLU5Z	V600-8205383
M8	8,4x24x2	250	RONPLU8Z	V600-8205382

Ø (mm)	Dimensions (mm)	Boîtage	Code	Référence
M10	10,5x30x2,5	200	RONPLU10Z	V600-8205381
M12	13x37x3	200	RONPLU12Z	V600-8205380

RONDELLE ÉVENTAIL DENTURE EXTÉRIEURE

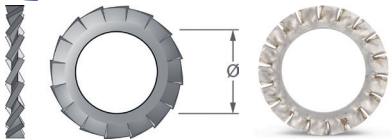

Ø	Dimensions (mm)	Boîtage	Code	Référence
M3	3,2x6x0,4	200	RONAZ3Z	V600-8205450
AZ4	4,5x8x0,5	200	RONAZ4Z	V600-8204043
AZ5	5,5x10x0,6	200	RONAZ5Z	V600-8204042
AZ6	6,6x11x0,7	200	RONAZ6Z	V600-8204041
AZ8	8,6x15x0,8	200	RONAZ8Z	V600-8204039
AZ10	10,8x18x0,9	100	RONAZ10Z	V600-8204038
AZ12	13,3x20,5x1	100	RONAZ12Z	V600-8204037

Ø	Dimensions (mm)	Boîtage	Code	Référence
M14	15x24x1	100	RONAZ14Z	V600-8205449
AZ16	17,3x26x1,2	100	RONAZ16Z	V600-8204036
M18	19x30x1,4	100	RONAZ18Z	V600-8205448
AZ20	21,3x33x1,4	100	RONAZ20Z	V600-8204035
M22	23x36x1,5	100	RONAZ22Z	V600-8205447
AZ24	25,3x38x1,5	100	RONAZ24Z	V600-8204034

Autres dimensions disponibles sur demande.

RONDELLE ÉLASTIQUE ÉVENTAIL DENTURE INTÉRIEURE

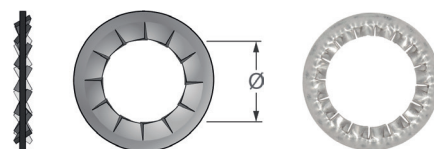

Ø	Dimensions (mm)	Boîtage	Code	Référence
JZ5	5,1x9x0,5	500	RONJZ5Z	V600-8204033
JZ6	6,4x11x0,7	500	RONJZ6Z	V600-8204032
JZ8	8,2x14x0,8	500	RONJZ8Z	V600-8204031
JZ10	10,5x18x0,9	500	RONJZ10Z	V600-8204030
JZ12	13x20,5x1	500	RONJZ12Z	V600-8204029
M14	15x24x1	500	RONJZ14Z	V600-8205446

Ø	Dimensions (mm)	Boîtage	Code	Référence
M16	17x26x1,2	500	RONJZ16Z	V600-8205445
M18	19x30x1,4	100	RONJZ18Z	V600-8205444
M20	21x33x1,4	100	RONJZ20Z	V600-8205443
M22	23x36x1,5	100	RONJZ22Z	V600-8205442
M24	25x38x1,5	100	RONJZ24Z	V600-8205441

Autres dimensions disponibles sur demande.

RONDELLE ÉLASTIQUE ÉVENTAIL DENTURE INTÉRIEURE LARGE ET BOMBÉE TYPE JZC

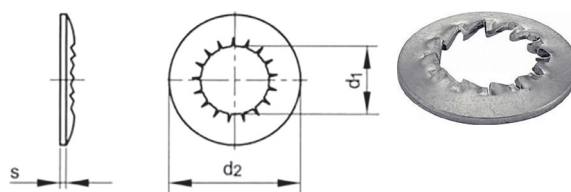

Ø (mm)	Dimensions (mm)	Boîtage	Code	Référence
M3	3,1x8,7x0,5	1000	RONJZC3Z	V600-8205440
M4	4,1x11x0,6	1000	RONJZC4Z	V600-8205439
M5	5,1x16x1	1000	RONJZC5Z	V600-8205438

Ø (mm)	Dimensions (mm)	Boîtage	Code	Référence
M6	6,1x18x1	1000	RONJZC6Z	V600-8205437
M10	10,2x26x1,4	100	RONJZC10Z	V600-8205436

RONDELLE GROWER

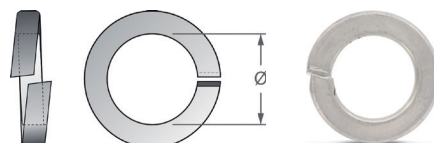

Ø	Dimensions (mm)	Boîtage	Code	Référence
M2,5	2,9x5,1x0,6	1000	RONW2,5Z	V600-8205462
M3	3,4x6,2x0,8	250	RONW3Z	V600-8205461
W4	4,1x7,6x0,9	250	RONW4Z	V600-8204028
W5	5,1x9,2x1,2	250	RONW5Z	V600-8204027
W6	6,1x11,8x1,6	250	RONW6Z	V600-8204026
W8	8,1x14,8x2	200	RONW8Z	V600-8204025
W10	10,2x18,1x2,2	200	RONW10Z	V600-8204024
W12	12,2x21,1x2,5	150	RONW12Z	V600-8204023
W14	14,2x24,1x3	100	RONW14Z	V600-8204022

Ø	Dimensions (mm)	Boîtage	Code	Référence
W16	16,2x27,4x3,5	100	RONW16Z	V600-8204021
W18	18,2x29,4x3,5	100	RONW18Z	V600-8204020
W20	20,2x33,6x4	100	RONW20Z	V600-8204019
W22	22,5x35,9x4	50	RONW22Z	V600-8204018
W24	24,5x40x5	50	RONW24Z	V600-8204017
M27	28,5x43x5	25	RONW27Z	V600-8205460
W30	30,5x48,2x6	25	RONW30Z	V600-8204016
M33	34x55x6	25	RONW33Z	V600-8205459

Autres dimensions disponibles sur demande.

RONDELLE CONTACT M

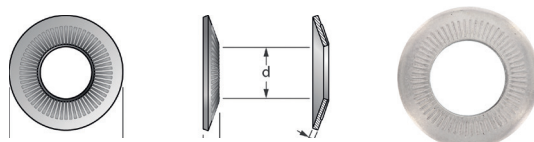

Ø	Dimensions (mm)	Boîtage	Code	Référence
M5	5,1x12x1,1	100	RONCTAM5Z	V600-8204048
M6	6,1x14x1,3	100	RONCTAM6Z	V600-8204047
M8	8,2x18x1,4	100	RONCTAM8Z	V600-8204046

Ø	Dimensions (mm)	Boîtage	Code	Référence
M10	10,2x22x1,6	100	RONCTAM10Z	V600-8204045
M12	12,4x27x1,8	100	RONCTAM12Z	V600-8204044

Autres dimensions disponibles sur demande.

Anfitec

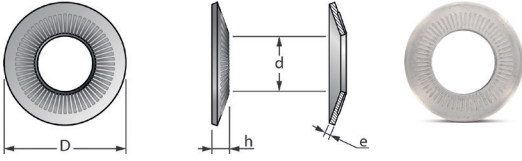

RONDELLE CONTACT M AVEC PASSIVATION CR (III) ÉPAISSE



Ø (mm)	Dimensions (mm)	Boîtage	Code	Référence
M3	3,1x8x1	200	RONCTA3Z	V600-8205453
M4	4,1x10x1,4	200	RONCTA4Z	V600-8205452
M16	16,4x32x4,1	100	RONCTA16Z	V600-8205451

Anfitec

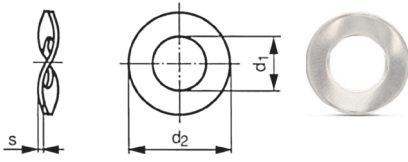

RONDELLE ÉLASTIQUE ONDULÉE



Ø (mm)	Dimensions (mm)	Boîtage	Code	Référence
M3	3,2x8x0,5	1000	RONFLEX3Z	V600-8205458
M5	5,3x11x0,5	1000	RONFLEX5Z	V600-8205457
M6	6,4x12x0,5	1000	RONFLEX6Z	V600-8205456
M8	8,4x15x0,8	1000	RONFLEX8Z	V600-8205455
M12	13x24x1,2	500	RONFLEX12Z	V600-8205454

Anfitec

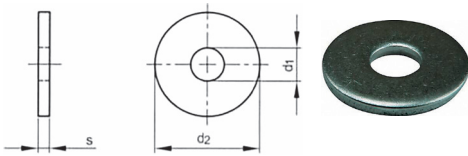

RONDELLE CARROSSIER



Ø (mm)	Dimensions (mm)	Boîtage	Code	Référence
M6	6,5x1,5	100	RONCAR6Z	V600-8205379
M8	8,4x1,5	100	RONCAR8Z	V600-8205378
M10	10,5x1,5	100	RONCAR10Z	V600-8205377
M12	12,5x1,5	100	RONCAR12Z	V600-8205376

Anfitec



TIGE FILETÉE 1M 4.6



Ø (mm)	Longueur (mm)	Code	Référence
3	1000	TF1M3	V600-8205743
6	1000	TF1M6	V600-8203955
8	1000	TF1M8	V600-8203954
10	1000	TF1M10	V600-8203953
12	1000	TF1M12	V600-8203952
14	1000	TF1M14	V600-8203951

Ø (mm)	Longueur (mm)	Code	Référence
16	1000	TF1M16	V600-8203950
18	1000	TF1M18	V600-8203949
20	1000	TF1M20	V600-8203948
22	1000	TF1M22	V600-8203947
24	1000	TF1M24	V600-8203946
30	1000	TF1M30	V600-8203945

Autres dimensions disponibles sur demande.

TIGE FILETÉE 1M 8.8



Ø (mm)	Longueur (mm)	Code	Référence
6	1000	TF1M6.8	V600-8203944
8	1000	TF1M8.8	V600-8203943
10	1000	TF1M10.8	V600-8203942
12	1000	TF1M12.8	V600-8203941
14	1000	TF1M14.8	V600-8203940
16	1000	TF1M16.8	V600-8203939

Ø (mm)	Longueur (mm)	Code	Référence
18	1000	TF1M18.8	V600-8203938
20	1000	TF1M20.8	V600-8203937
22	1000	TF1M22.8	V600-8203936
24	1000	TF1M24.8	V600-8203935
30	1000	TF1M30.8	V600-8203934

Autres dimensions disponibles sur demande.

VIS TÊTE HEXAGONALE 8.8 ZG



Dimensions ØxL (mm)	Filetage	Clé	Boitage	Code	Référence
3x6	Total	5.5	500	TH3X6EF8Z	V600-8207938
3X10	Total	5.5	500	TH3X10EF8Z	V600-8203355
3x16	Total	5.5	500	TH3X16EF8Z	V600-8207937
3x20	Total	5.5	500	TH3X20EF8Z	V600-8207936
3x30	Total	5.5	500	TH3X30EF8Z	V600-8207935
4x6	Total	7	500	TH4X6EF8Z	V600-8207934
4X8	Total	7	500	TH4X8EF8Z	V600-8203354
4X10	Total	7	500	TH4X10EF8Z	V600-8203353
4X12	Total	7	500	TH4X12EF8Z	V600-8203352
4X20	Total	7	500	TH4X20EF8Z	V600-8203351
4X25	Total	7	500	TH4X25EF8Z	V600-8203350
4X30	Total	7	500	TH4X30EF8Z	V600-8203349
4X35	Total	7	500	TH4X35EF8Z	V600-8203347
4X40	Total	7	500	TH4X40EF8Z	V600-8203345
4X45	Total	7	500	TH4X45EF8Z	V600-8203343
4X50	Total	7	500	TH4X50EF8Z	V600-8203341
5X8	Total	8	200	TH5X8EF8Z	V600-8203339
5X10	Total	8	200	TH5X10EF8Z	V600-8203338
5X12	Total	8	200	TH5X12EF8Z	V600-8203337
5x16	Total	8	200	TH5X16EF8Z	V600-8207933
5X20	Total	8	200	TH5X20EF8Z	V600-8203336
5X25	Total	8	200	TH5X25EF8Z	V600-8203335
5X30	Total	8	200	TH5X30EF8Z	V600-8203334
5X35	Total	8	200	TH5X35EF8Z	V600-8203333
5X40	Total	8	200	TH5X40EF8Z	V600-8203332
5X45	Total	8	200	TH5X45EF8Z	V600-8203331
5X50	Total	8	200	TH5X50EF8Z	V600-8203330
5x70	Total	8	200	TH5X70EF8Z	V600-8207932
6x8	Total	10	200	TH6X8EF8Z	V600-8207931
6X10	Total	10	200	TH6X10EF8Z	V600-8203329
6X12	Total	10	200	TH6X12EF8Z	V600-8203328
6x14	Total	10	200	TH6X14EF8Z	V600-8207930
6X16	Total	10	200	TH6X16EF8Z	V600-8203327
6x18	Total	10	200	TH6X18EF8Z	V600-8207929
6X20	Total	10	200	TH6X20EF8Z	V600-8203326
6X25	Total	10	200	TH6X25EF8Z	V600-8203325
6X30	Total	10	200	TH6X30EF8Z	V600-8203324
6X35	Total	10	200	TH6X35EF8Z	V600-8203323
6X40	Total	10	200	TH6X40EF8Z	V600-8203322
6X45	Total	10	200	TH6X45EF8Z	V600-8203321

Dimensions ØxL (mm)	Filetage	Clé	Boitage	Code	Référence
6X50	Total	10	200	TH6X50EF8Z	V600-8203320
6x55	Total	10	200	TH6X55EF8Z	V600-8207928
6X60	Total	10	200	TH6X60EF8Z	V600-8203319
6X70	Total	10	200	TH6X70EF8Z	V600-8203318
6x80	Total	10	200	TH6X80EF8Z	V600-8207927
6x90	Total	10	100	TH6X90EF8Z	V600-8207926
6X100	Total	10	100	TH6X100EF8Z	V600-8203315
8X10	Total	13	200	TH8X10EF8Z	V600-8203314
8X12	Total	13	200	TH8X12EF8Z	V600-8203313
8X16	Total	13	200	TH8X16EF8Z	V600-8203312
8X20	Total	13	200	TH8X20EF8Z	V600-8203311
8X25	Total	13	200	TH8X25EF8Z	V600-8203310
8X30	Total	13	200	TH8X30EF8Z	V600-8203309
8X35	Total	13	200	TH8X35EF8Z	V600-8203307
8X40	Total	13	200	TH8X40EF8Z	V600-8203306
8X45	Total	13	200	TH8X45EF8Z	V600-8203304
8X50	Total	13	200	TH8X50EF8Z	V600-8203303
8X55	Total	13	200	TH8X55EF8Z	V600-8203301
8X60	Total	13	200	TH8X60EF8Z	V600-8203300
8x65	Total	13	200	TH8X65EF8Z	V600-8207925
8X70	Total	13	200	TH8X70EF8Z	V600-8203297
8X80	Total	13	200	TH8X80EF8Z	V600-8203296
8x90	Total	13	100	TH8X90EF8Z	V600-8207924
8x100	Total	13	100	TH8X100EF8Z	V600-8207923
8x110	Total	13	100	TH8X110EF8Z	V600-8207922
10x10	Total	17	200	TH10X10EF8Z	V600-8207921
10X16	Total	17	200	TH10X16EF8Z	V600-8203290
10X20	Total	17	200	TH10X20EF8Z	V600-8203289
10X20	Total	16	200	TH10X20EF8ZISO	V600-8203288
10X25	Total	17	200	TH10X25EF8Z	V600-8203287
10X25	Total	16	200	TH10X25EF8ZISO	V600-8203286
10X30	Total	17	200	TH10X30EF8Z	V600-8203285
10X30	Total	16	200	TH10X30EF8ZISO	V600-8203284
10X35	Total	17	100	TH10X35EF8Z	V600-8203283
10X35	Total	16	100	TH10X35EF8ZISO	V600-8203282
10X40	Total	17	100	TH10X40EF8Z	V600-8203281
10X40	Total	16	100	TH10X40EF8ZISO	V600-8203280
10X45	Total	17	100	TH10X45EF8Z	V600-8203277
10X50	Total	17	100	TH10X50EF8Z	V600-8203275
10X50	Total	16	100	TH10X50EF8ZISO	V600-8203274



DIN
912

ISO
4762

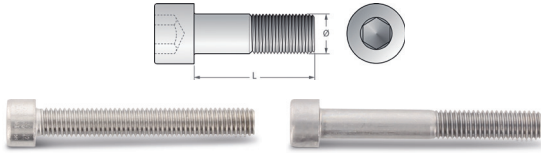

Dimensions ØxL (mm)	Filetage	Clé	Boilage	Code	Référence
3x6	Total	2.5	200	CHC3X6EF8Z	V600-8206143
3x8	Total	2.5	200	CHC3X8EF8Z	V600-8206142
3x10	Total	2.5	200	CHC3X10EF8Z	V600-8206141
3x12	Total	2.5	200	CHC3X12EF8Z	V600-8206140
3X16	Total	2.5	200	CHC3X16EF8Z	V600-8203911
3X20	Total	2.5	200	CHC3X20EF8Z	V600-8203910
4x8	Total	3	200	CHC4X8EF8Z	V600-8208771
4X10	Total	3	200	CHC4X10EF8Z	V600-8203909
4X12	Total	3	200	CHC4X12EF8Z	V600-8203908
4X16	Total	3	200	CHC4X16EF8Z	V600-8203907
4X20	Total	3	200	CHC4X20EF8Z	V600-8203906
4X25	Total	3	200	CHC4X25EF8Z	V600-8203905
4X30	Partiel	3	200	CHC4X30PF8Z	V600-8203904
4X35	Partiel	3	200	CHC4X35PF8Z	V600-8203903
4X40	Total	3	200	CHC4X40EF8Z	V600-8203902
4x45	Total	3	200	CHC4X45EF8Z	V600-8208770
4x50	Total	3	200	CHC4X50EF8Z	V600-8208769
5X10	Total	4	200	CHC5X10EF8Z	V600-8203901
5X12	Total	4	200	CHC5X12EF8Z	V600-8203900
5X16	Total	4	200	CHC5X16EF8Z	V600-8203899
5X20	Total	4	200	CHC5X20EF8Z	V600-8203898
5X25	Total	4	200	CHC5X25EF8Z	V600-8203897
5X30	Partiel	4	200	CHC5X30PF8Z	V600-8203896
5X35	Partiel	4	200	CHC5X35PF8Z	V600-8203895
5X40	Partiel	4	200	CHC5X40PF8Z	V600-8203894
5X45	Partiel	4	200	CHC5X45PF8Z	V600-8203893
5X50	Partiel	4	200	CHC5X50PF8Z	V600-8203892
5X60	Partiel	4	200	CHC5X60PF8Z	V600-8203891
6X10	Total	5	200	CHC6X10EF8Z	V600-8203890
6X12	Total	5	200	CHC6X12EF8Z	V600-8203889
6X16	Total	5	200	CHC6X16EF8Z	V600-8203888
6X20	Total	5	200	CHC6X20EF8Z	V600-8203887
6X25	Total	5	200	CHC6X25EF8Z	V600-8203886
6X30	Total	5	200	CHC6X30EF8Z	V600-8203885
6X35	Total	5	200	CHC6X35EF8Z	V600-8203884
6X40	Partiel	5	200	CHC6X40PF8Z	V600-8203883
6X45	Partiel	5	200	CHC6X45PF8Z	V600-8203882
6X50	Partiel	5	200	CHC6X50PF8Z	V600-8203881

Dimensions ØxL (mm)	Filetage	Clé	Boilage	Code	Référence
6X60	Partiel	5	200	CHC6X60PF8Z	V600-8203880
6X70	Partiel	5	200	CHC6X70PF8Z	V600-8203879
6X80	Partiel	5	200	CHC6X80PF8Z	V600-8203878
8x10	Total	6	200	CHC8X10EF8Z	V600-8206139
8X12	Total	6	200	CHC8X12EF8Z	V600-8203877
8X16	Total	6	200	CHC8X16EF8Z	V600-8203876
8X20	Total	6	200	CHC8X20EF8Z	V600-8203875
8X25	Total	6	200	CHC8X25EF8Z	V600-8203874
8X30	Total	6	200	CHC8X30EF8Z	V600-8203873
8X35	Total	6	200	CHC8X35EF8Z	V600-8203872
8X40	Partiel	6	200	CHC8X40PF8Z	V600-8203871
8X45	Partiel	6	200	CHC8X45PF8Z	V600-8203870
8X50	Partiel	6	200	CHC8X50PF8Z	V600-8203869
8X60	Partiel	6	200	CHC8X60PF8Z	V600-8203868
8X70	Partiel	6	200	CHC8X70PF8Z	V600-8203867
8x80	Partiel	6	200	CHC8X80PF8Z	V600-8208768
8x90	Partiel	6	100	CHC8X90PF8Z	V600-8207521
8x100	Partiel	6	100	CHC8X100PF8Z	V600-8207520
10X25	Total	8	200	CHC10X25EF8Z	V600-8203864
10X30	Total	8	200	CHC10X30EF8Z	V600-8203863
10X35	Total	8	100	CHC10X35EF8Z	V600-8203862
10X40	Partiel	8	100	CHC10X40PF8Z	V600-8203861
10X45	Partiel	8	100	CHC10X45PF8Z	V600-8203860
10X50	Partiel	8	100	CHC10X50PF8Z	V600-8203859
10X60	Partiel	8	100	CHC10X60PF8Z	V600-8203858
10x70	Partiel	8	100	CHC10X70PF8Z	V600-8208767
10X100	Total	8	50	CHC10X100EF8Z	V600-8203857
12X25	Total	10	100	CHC12X25EF8Z	V600-8203856
12X30	Total	10	100	CHC12X30EF8Z	V600-8203855
12x35	Total	10	100	CHC12X35EF8Z	V600-8206138
12X40	Partiel	10	100	CHC12X40PF8Z	V600-8203854
12X50	Partiel	10	100	CHC12X50PF8Z	V600-8203853
12X60	Partiel	10	100	CHC12X60PF8Z	V600-8203852
12X70	Partiel	10	50	CHC12X70PF8Z	V600-8203851
14x30	Total	12	100	CHC14X30EF8Z	V600-8206137
16X40	Total	14	50	CHC16X40EF8Z	V600-8203850
16X50	Total	14	50	CHC16X50EF8Z	V600-8203849
20x60	Partiel	17	25	CHC20X60PF8Z	V600-8208766

Autres dimensions disponibles sur demande.

Réapprovisionnez
votre visserie avec
notre solution scan !



NOUVEAU

- Depuis notre appli mobile Rubix
- Réapro simple et rapide
- Historique des commandes
- Suivi des livraisons



VIS TÊTE CYLINDRIQUE FENDUE 4.8



Dimensions ØxL (mm)	Filetage	Boilage	Code	Référence
2X6	Total	200	VTCFDU2X6Z	V600-8203763
2X8	Total	200	VTCFDU2X8Z	V600-8203762
2X16	Total	200	VTCFDU2X16Z	V600-8203761
2,5X6	Total	200	VTCFDU2,5X6Z	V600-8203760
2,5X8	Total	200	VTCFDU2,5X8Z	V600-8203759
2,5X10	Total	200	VTCFDU2,5X10Z	V600-8203758
2,5X15	Total	200	VTCFDU2,5X15Z	V600-8203757
2,5X20	Total	200	VTCFDU2,5X20Z	V600-8203756
2,5x25	Total	200	VTCFDU2,5X25Z	V600-8205742
3X4	Total	200	VTCFDU3X4Z	V600-8203755
3x6	Total	200	VTCFDU3X6Z	V600-8205741
3X8	Total	200	VTCFDU3X8Z	V600-8203754
3x10	Total	200	VTCFDU3X10Z	V600-8205740
3x12	Total	200	VTCFDU3X12Z	V600-8205739
3x16	Total	200	VTCFDU3X16Z	V600-8205738
3x20	Total	200	VTCFDU3X20Z	V600-8205737
3x25	Total	200	VTCFDU3X25Z	V600-8205736
3x30	Total	200	VTCFDU3X30Z	V600-8205735
3X35	Total	200	VTCFDU3X35Z	V600-8203753
3X40	Total	200	VTCFDU3X40Z	V600-8203752
3x60	Total	200	VTCFDU3X60Z	V600-8205734
4X5	Total	200	VTCFDU4X5Z	V600-8203751
4X6	Total	200	VTCFDU4X6Z	V600-8203750
4x8	Total	200	VTCFDU4X8Z	V600-8205733
4x10	Total	200	VTCFDU4X10Z	V600-8205732
4x12	Total	200	VTCFDU4X12Z	V600-8205731
4X14	Total	200	VTCFDU4X14Z	V600-8203749
4x16	Total	200	VTCFDU4X16Z	V600-8205730
4x20	Total	200	VTCFDU4X20Z	V600-8205729
4X25	Total	200	VTCFDU4X25Z	V600-8203748
4x30	Total	200	VTCFDU4X30Z	V600-8205728
4X35	Total	200	VTCFDU4X35Z	V600-8203747
4x40	Total	200	VTCFDU4X40Z	V600-8205727

Dimensions ØxL (mm)	Filetage	Boilage	Code	Référence
4x45	Total	200	VTCFDU4X45Z	V600-8205726
4x70	Total	200	VTCFDU4X70Z	V600-8205725
4x80	Total	200	VTCFDU4X80Z	V600-8205724
5X8	Total	200	VTCFDU5X8Z	V600-8203746
5X80	Total	100	VTCFDU5X80Z	V600-8203745
5x10	Total	200	VTCFDU5X10Z	V600-8205723
5x12	Total	200	VTCFDU5X12Z	V600-8205722
5x16	Total	200	VTCFDU5X16Z	V600-8205721
5x20	Total	200	VTCFDU5X20Z	V600-8205720
5x25	Total	200	VTCFDU5X25Z	V600-8205719
5x30	Total	200	VTCFDU5X30Z	V600-8205718
5x35	Total	200	VTCFDU5X35Z	V600-8205717
5x40	Total	200	VTCFDU5X40Z	V600-8205716
5x45	Total	200	VTCFDU5X45Z	V600-8205715
5x50	Total	200	VTCFDU5X50Z	V600-8205714
5x55	Total	100	VTCFDU5X55Z	V600-8205713
5x60	Total	200	VTCFDU5X60Z	V600-8205712
5x70	Total	200	VTCFDU5X70Z	V600-8205711
6x10	Total	200	VTCFDU6X10Z	V600-8205710
6X12	Total	200	VTCFDU6X12Z	V600-8203744
6x16	Total	200	VTCFDU6X16Z	V600-8205709
6x20	Total	200	VTCFDU6X20Z	V600-8205708
6x30	Total	200	VTCFDU6X30Z	V600-8205707
6x35	Total	200	VTCFDU6X35Z	V600-8205706
6x40	Total	200	VTCFDU6X40Z	V600-8205705
6x50	Total	200	VTCFDU6X50Z	V600-8205704
6x60	Total	200	VTCFDU6X60Z	V600-8205703
6x70	Total	200	VTCFDU6X70Z	V600-8205702
6x100	Total	200	VTCFDU6X100Z	V600-8205701
8x20	Total	200	VTCFDU8X20Z	V600-8205700
8x30	Total	200	VTCFDU8X30Z	V600-8205699
8X35	Total	200	VTCFDU8X35Z	V600-8203743
8x40	Total	200	VTCFDU8X40Z	V600-8205698

Autres dimensions disponibles sur demande.

Habillez votre magasin avec tout l'équipement GISS spécial visserie !



Rayonnage à tablettes tôlées

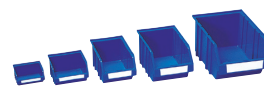

Bacs à bec

Pour un devis, contactez votre agence.

VIS TÊTE CYLINDRIQUE À EMPREINTE CRUCIFORME

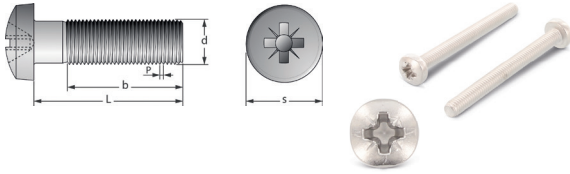

Dimensions ØxL (mm)	Filetage	Boîtage	Code	Référence
3x6	Total	2000	VTCPOZ3X6Z	V600-8205697
3x8	Total	2000	VTCPOZ3X8Z	V600-8205696
3x10	Total	2000	VTCPOZ3X10Z	V600-8205695
3x12	Total	2000	VTCPOZ3X12Z	V600-8205694
3x16	Total	2000	VTCPOZ3X16Z	V600-8205693
3x20	Total	2000	VTCPOZ3X20Z	V600-8205692
3x30	Total	2000	VTCPOZ3X30Z	V600-8205691
4x10	Total	1000	VTCPOZ4X10Z	V600-8205690
4x16	Total	1000	VTCPOZ4X16Z	V600-8205689
4x20	Total	1000	VTCPOZ4X20Z	V600-8205688
4x25	Total	1000	VTCPOZ4X25Z	V600-8205687
4x30	Total	1000	VTCPOZ4X30Z	V600-8205686
4x40	Total	500	VTCPOZ4X40Z	V600-8205685
4x60	Total	500	VTCPOZ4X60Z	V600-8205684
5x10	Total	1000	VTCPOZ5X10Z	V600-8205683
5x16	Total	1000	VTCPOZ5X16Z	V600-8205682

Dimensions ØxL (mm)	Filetage	Boîtage	Code	Référence
5x20	Total	500	VTCPOZ5X20Z	V600-8205681
5x25	Total	500	VTCPOZ5X25EF4.8Z	V600-8208758
5x30	Total	250	VTCPOZ5X30Z	V600-8205680
5x40	Total	250	VTCPOZ5X40Z	V600-8205679
5x45	Total	250	VTCPOZ5X45Z	V600-8205678
5x60	Total	200	VTCPOZ5X60Z	V600-8205677
6x12	Total	1000	VTCPOZ6X12Z	V600-8205676
6x16	Total	500	VTCPOZ6X16Z	V600-8205675
6x20	Total	250	VTCPOZ6X20Z	V600-8205674
6x25	Total	250	VTCPOZ6X25Z	V600-8205673
6x40	Total	250	VTCPOZ6X40Z	V600-8205672
6x50	Total	250	VTCPOZ6X50Z	V600-8205671
6x60	Total	250	VTCPOZ6X60Z	V600-8205670
6x70	Total	125	VTCPOZ6X70Z	V600-8205669
8x20	Total	250	VTCPOZ8X20EF4.8Z	V600-8208757
8x40	Total	100	VTCPOZ8X40Z	V600-8205668

VIS À TÔLE À TÊTE CYLINDRIQUE BOMBÉE LARGE À EMPREINTE CRUCIFORME



Dimensions ØxL (mm)	Filetage	Boîtage	Code	Référence
3,5X16	Total	200	VTCBPOZ3,5X16Z	V600-8205620
3,5X25	Total	200	VTCBPOZ3,5X25Z	V600-8205619
3,9X19	Total	200	VTCBPOZ3,9X19Z	V600-8205618
4,2X16	Total	200	VTCBPOZ4,2X16Z	V600-8205617
4,2X19	Total	200	VTCBPOZ4,2X19Z	V600-8205616
4,2X32	Total	200	VTCBPOZ4,2X32Z	V600-8205615

Dimensions ØxL (mm)	Filetage	Boîtage	Code	Référence
4,8X16	Total	200	VTCBPOZ4,8X16Z	V600-8205614
4,8X19	Total	200	VTCBPOZ4,8X19Z	V600-8205613
4,8X25	Total	200	VTCBPOZ4,8X25Z	V600-8205612
4,8X32	Total	100	VTCBPOZ4,8X32Z	V600-8205611
5,5X19	Total	200	VTCBPOZ5,5X19Z	V600-8205610
6,3X16	Total	100	VTCBPOZ6,3X16Z	V600-8205609

VIS POUR AGGLOMÉRÉ À TÊTE BOMBÉE À EMPREINTE CRUCIFORME



Dimensions ØxL (mm)	Filetage	Boîtage	Code	Référence
4x12	Total	200	VATCB4X12POZZ	V600-8208753

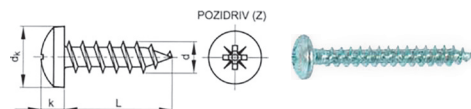

VIS FHC - TÊTE FRAISÉE HEXAGONALE CREUSE 10.9



Dimensions ØxL (mm)	Filetage	Clé	Boîtage	Code	Référence
3x10	Partiel	2	500	FHC3X10PF10Z	V600-8205984
3x12	Partiel	2	500	FHC3X12PF10Z	V600-8205983
3x16	Partiel	2	500	FHC3X16PF10Z	V600-8205982
3x20	Partiel	2	500	FHC3X20PF10Z	V600-8205981
3x25	Partiel	2	500	FHC3X25PF10Z	V600-8205980
3x30	Partiel	2	500	FHC3X30PF10Z	V600-8205979
4X10	Total	2.5	500	FHC4X10EF10Z	V600-8203933
4X16	Total	2.5	500	FHC4X16EF10Z	V600-8203932
4x30	Partiel	2.5	500	FHC4X30PF10Z	V600-8208765
4x35	Partiel	2.5	500	FHC4X35PF10Z	V600-8205978
4x40	Partiel	2.5	500	FHC4X40PF10Z	V600-8205977
5x8	Total	3	500	FHC5X8EF10ZISO	V600-8205976
5X10	Total	3	500	FHC5X10EF10Z	V600-8203931
5X16	Total	3	500	FHC5X16EF10Z	V600-8203929
5X20	Total	3	500	FHC5X20EF10Z	V600-8203928
5x25	Partiel	3	500	FHC5X25PF10Z	V600-8205975
5X30	Total	3	500	FHC5X30EF10Z	V600-8203927
5x35	Partiel	3	200	FHC5X35PF10Z	V600-8205974
6X10	Total	4	500	FHC6X10EF10Z	V600-8203926
6x12	Partiel	4	500	FHC6X12PF10Z	V600-8205973
6X16	Total	4	500	FHC6X16EF10Z	V600-8203925
6X20	Total	4	500	FHC6X20EF10Z	V600-8203924
6X25	Total	4	200	FHC6X25EF10Z	V600-8203923

Dimensions ØxL (mm)	Filetage	Clé	Boîtage	Code	Référence
6X30	Total	4	500	FHC6X30EF10Z	V600-8203922
6x40	Total	4	200	FHC6X40EF10Z	V600-8205972
6x45	Total	4	200	FHC6X45EF10ZISO	V600-8205971
6x70	Partiel	4	200	FHC6X70PF10Z	V600-8205970
6x80	Partiel	4	200	FHC6X80PF10Z	V600-8205969
8X16	Total	5	200	FHC8X16EF10Z	V600-8203921
8X20	Total	5	200	FHC8X20EF10Z	V600-8203920
8X25	Total	5	200	FHC8X25EF10Z	V600-8203919
8X30	Total	5	200	FHC8X30EF10Z	V600-8203918
8X40	Total	5	200	FHC8X40EF10Z	V600-8203917
8x45	Partiel	5	200	FHC8X45PF10Z	V600-8205968
10x25	Total	6	200	FHC10X25EF10Z	V600-8205967
10x30	Total	6	200	FHC10X30EF10Z	V600-8205966
10x35	Total	6	100	FHC10X35EF10Z	V600-8208764
10x70	Total	6	100	FHC10X70EF10Z	V600-8205965
12x30	Total	8	100	FHC12X30EF10Z	V600-8208763
12X40	Total	8	100	FHC12X40EF10Z	V600-8203916
12x45	Total	8	100	FHC12X45EF10Z	V600-8205964
14X50	Total	10	50	FHC14X50EF10Z	V600-8203915
16X40	Total	10	50	FHC16X40EF10Z	V600-8203914
16X50	Total	10	50	FHC16X50EF10Z	V600-8203913
16X60	Total	10	50	FHC16X60EF10Z	V600-8203912

Autres dimensions disponibles sur demande.

Réapprovisionnez
votre visserie avec
notre solution scan !



NOUVEAU

- Depuis notre appli mobile Rubix
- Réappro simple et rapide
- Historique des commandes
- Suivi des livraisons



VIS À TÊTE FRAISÉE À EMPREINTE CRUCIFORME

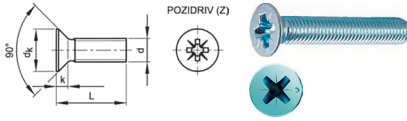

Dimensions ØxL (mm)	Filetage	Boîtage	Code	Référence
3x6	Total	2000	VTFP0Z3X6Z	V600-8205667
3x8	Total	2000	VTFP0Z3X8Z	V600-8205666
3x10	Total	2000	VTFP0Z3X10Z	V600-8205665
3x12	Total	2000	VTFP0Z3X12Z	V600-8205664
3x16	Total	2000	VTFP0Z3X16Z	V600-8205663
3x20	Total	2000	VTFP0Z3X20Z	V600-8205662
3x25	Total	2000	VTFP0Z3X25Z	V600-8205661
3x30	Total	1000	VTFP0Z3X30Z	V600-8205660
4x8	Total	1000	VTFP0Z4X8Z	V600-8205659
4x10	Total	1000	VTFP0Z4X10Z	V600-8205658
4x16	Total	1000	VTFP0Z4X16Z	V600-8205657
4x20	Total	1000	VTFP0Z4X20Z	V600-8205656
4x30	Total	1000	VTFP0Z4X30Z	V600-8205655
4x35	Total	1000	VTFP0Z4X35Z	V600-8205654
4x40	Total	1000	VTFP0Z4X40Z	V600-8205653
4x60	Total	500	VTFP0Z4X60Z	V600-8205652
5x10	Total	1000	VTFP0Z5X10Z	V600-8205651
5x12	Total	1000	VTFP0Z5X12Z	V600-8205650
5x16	Total	1000	VTFP0Z5X16Z	V600-8205649

Dimensions ØxL (mm)	Filetage	Boîtage	Code	Référence
5x20	Total	500	VTFP0Z5X20Z	V600-8205648
5x25	Total	500	VTFP0Z5X25Z	V600-8205647
5x30	Total	250	VTFP0Z5X30Z	V600-8205646
5x35	Total	250	VTFP0Z5X35Z	V600-8205645
5x40	Total	250	VTFP0Z5X40Z	V600-8205644
5x50	Total	250	VTFP0Z5X50Z	V600-8205643
5x60	Total	250	VTFP0Z5X60Z	V600-8205642
5x80	Total	200	VTFP0Z5X80Z	V600-8205641
6x10	Total	1000	VTFP0Z6X10Z	V600-8205640
6x20	Total	250	VTFP0Z6X20Z	V600-8205639
6x25	Total	250	VTFP0Z6X25Z	V600-8205638
6x30	Total	250	VTFP0Z6X30Z	V600-8205637
6x40	Total	250	VTFP0Z6X40Z	V600-8205636
6x45	Total	200	VTFP0Z6X45Z	V600-8205635
6x50	Total	250	VTFP0Z6X50Z	V600-8205634
8x30	Total	250	VTFP0Z8X30Z	V600-8205633
8x40	Total	100	VTFP0Z8X40Z	V600-8208756
8x80	Total	100	VTFP0Z8X80Z	V600-8205632

VIS À TÔLE À TÊTE FRAISÉE À EMPREINTE CRUCIFORME

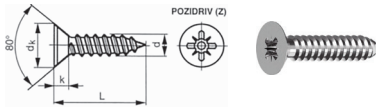

Dimensions ØxL (mm)	Filetage	Boîtage	Code	Référence
4,2x13	Total	200	VTFP0Z4,2X13Z	V600-8205608
4,8x16	Total	200	VTFP0Z4,8X16Z	V600-8208754

VIS À TÔLE À TÊTE FRAISÉE BOMBÉE À EMPREINTE CRUCIFORME

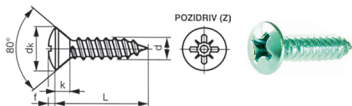

Dimensions ØxL (mm)	Filetage	Boîtage	Code	Référence
4,2X13	Total	200	VTFBP0Z4,2X13Z	V600-8205607

VIS À TÔLE À TÊTE FRAISÉE BOMBÉE À EMPREINTE CRUCIFORME



DIN
7983

ISO
7051CZ

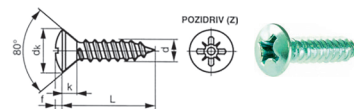

Dimensions ØxL (mm)	Filetage	Boîtage	Code	Référence
4,8X13	Total	200	VTFBPOZ4,8X13Z	V600-8205606
4,8X25	Total	200	VTFBPOZ4,8X25Z	V600-8205605

VIS POUR AGGLOMÉRÉE À TÊTE FRAISÉE À SIX LOBES INTERNES

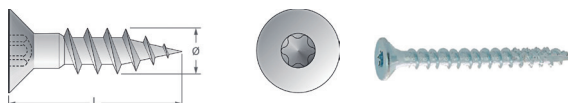

Dimensions ØxL (mm)	Filetage	Boîtage	Code	Référence
3,5x16	Total	200	VBEFRX3,5X16EFZ	V600-8205604
4,5x45	Partiel	200	VAPTF4,4X45PFTORXZ	V600-8205603
4,5x50	Partiel	200	VAPTF4,5X50PFTORXZ	V600-8205602
5x45	Total	200	VAPTF5X45EFTORXZ	V600-8205601
5x100	Partiel	200	VAPTF5X100PFTORXZ	V600-8205600

Dimensions ØxL (mm)	Filetage	Boîtage	Code	Référence
6x70	Partiel	200	VAPTF6X70PFTORXZ	V600-8205599
6x110	Partiel	100	VAPTF6X110PFTORXZ	V600-8205598
6x120	Total	100	VAPTF6X120EFTORXZ	V600-8205597
6x130	Partiel	100	VAPTF6X130PFTORXZ	V600-8205596
6x140	Partiel	100	VAPTF6X140PFTORXZ	V600-8205595

VIS À TÊTE FRAISÉE FENDUE



DIN
963

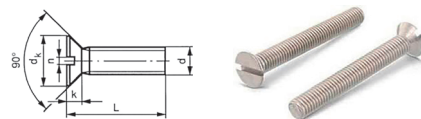

Dimensions ØxL (mm)	Filetage	Boîtage	Code	Référence
3x10	Total	200	VTFFDU3X10EF4.8Z	V600-8208761
8x30	Total	200	VTFFDU8X30EF4.8Z	V600-8208760
5x10	Total	500	VTFFDU5X10EF4.8Z	V600-8208759

VIS À TÊTE FRAISÉE À SIX LOBES INTERNES



DIN
965

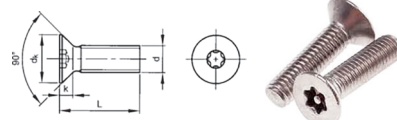

Dimensions ØxL (mm)	Filetage	Boîtage	Code	Référence
6x16	Total	200	VTFL0B6X16Z	V600-8208755

VIS POUR AGGLOMÉRÉ TÊTE FRAISÉE TORX



Dimensions ØxL (mm)	Filetage	Clé	Boî- tage	Code	Référence
3X20	Total	T10	200	VAPTF3X20EFTORXZ	V600-8203697
3X30	Total	T10	200	VAPTF3X30EFTORXZ	V600-8203696
3X40	Total	T10	500	VAPTF3X40EFTORXZ	V600-8203695
4X20	Total	T20	200	VAPTF4X20EFTORXZ	V600-8203694
4X30	Total	T20	200	VAPTF4X30EFTORXZ	V600-8203693
4X40	Total	T20	200	VAPTF4X40EFTORXZ	V600-8203692

Dimensions ØxL (mm)	Filetage	Clé	Boî- tage	Code	Référence
4X50	Total	T20	200	VAPTF4X50EFTORXZ	V600-8203691
5X30	Total	T25	200	VAPTF5X30EFTORXZ	V600-8203690
5X40	Total	T25	200	VAPTF5X40EFTORXZ	V600-8203689
5X50	Total	T25	200	VAPTF5X50EFTORXZ	V600-8203688
5X80	Total	T25	200	VAPTF5X80PFTORXZ	V600-8203687
6X50	Total	T30	200	VAPTF6X50PFTORXZ	V600-8203686

Autres dimensions disponibles sur demande.

VIS POUR AGGLOMÉRÉ À TÊTE CYLINDRIQUE BOMBÉE À EMPREINTE CRUCIFORME

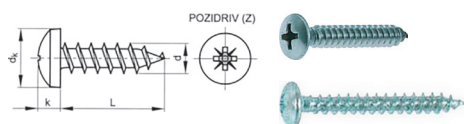

Dimensions ØxL (mm)	Filetage	Boî- tage	Code	Référence
3x30	Partiel	200	VATR3X30POZPF	V600-8205594
4x20	Partiel	200	VATR4X20POZPF	V600-8205593
4x30	Partiel	200	VATR4X30POZPF	V600-8205592
4x40	Partiel	200	VATR4X40POZPF	V600-8205591
4x50	Partiel	200	VATR4X50POZPF	V600-8205590

Dimensions ØxL (mm)	Filetage	Boî- tage	Code	Référence
5x30	Partiel	200	VATR5X30POZPF	V600-8205589
5x35	Partiel	200	VATR5X35POZPF	V600-8205588
5x40	Partiel	200	VATR5X40POZPF	V600-8205587
6x40	Partiel	200	VATR6X40POZPF	V600-8205586

VIS AUTOPERÇEUSE TÊTE HEXAGONALE



Dimensions ØxL (mm)	Filetage	Clé	Boî- tage	Code	Référence
3,5X10	Total	5.5	500	VPTH3,5X10Z	V600-8203633
3,5X13	Total	5.5	500	VPTH3,5X13Z	V600-8203632
3,5X16	Total	5.5	500	VPTH3,5X16Z	V600-8203631
3,5X19	Total	5.5	500	VPTH3,5X19Z	V600-8203630
3,9X16	Total	5.5	1000	VPTH3,9X16Z	V600-8205560
3,5X25	Total	5.5	500	VPTH3,5X25Z	V600-8203629
3,9X13	Total	5.5	500	VPTH3,9X13Z	V600-8203628
3,9X19	Total	5.5	1000	VPTH3,9X19Z	V600-8205559
5,5X60	Total	5.5	1000	VPTH3,9X19Z	V600-8205558
4,2X13	Total	7	500	VPTH4,2X13Z	V600-8203627
4,2X16	Total	7	500	VPTH4,2X16Z	V600-8203626
4,2X19	Total	7	500	VPTH4,2X19Z	V600-8203625
4,2X22	Total	7	500	VPTH4,2X22Z	V600-8203624
4,2X25	Total	7	500	VPTH4,2X25Z	V600-8203623
4,2X32	Total	7	500	VPTH4,2X32Z	V600-8205196
4,2X38	Total	7	500	VPTH4,2X38Z	V600-8203621
4,8X13	Total	8	500	VPTH4,8X13Z	V600-8205197
4,8X16	Total	8	500	VPTH4,8X16Z	V600-8205198
4,8X19	Total	8	500	VPTH4,8X19Z	V600-8203618
4,8X22	Total	8	500	VPTH4,8X22Z	V600-8203617
4,8X25	Total	8	500	VPTH4,8X25Z	V600-8205199
4,8X32	Total	8	500	VPTH4,8X32Z	V600-8205200

Dimensions ØxL (mm)	Filetage	Clé	Boî- tage	Code	Référence
4,8X38	Total	8	500	VPTH4,8X38Z	V600-8203614
4,8X50	Total	8	500	VPTH4,8X50Z	V600-8203613
5,5X19	Total	8	500	VPTH5,5X19Z	V600-8203612
5,5X22	Total	8	500	VPTH5,5X22Z	V600-8205207
5,5X25	Total	8	500	VPTH5,5X25Z	V600-8203611
5,5X32	Total	8	500	VPTH5,5X32Z	V600-8205201
5,5X38	Total	8	500	VPTH5,5X38Z	V600-8203609
5,5X80	Total	8	100	VPTH5,5X60Z	V600-8205557
6,3X120	Total	8	100	VPTH5,5X80Z	V600-8205556
6,3X19	Total	10	500	VPTH6,3X19Z	V600-8203608
6,3X22	Total	10	500	VPTH6,3X22Z	V600-8203607
6,3X25	Total	10	500	VPTH6,3X25Z	V600-8203606
6,3X32	Total	10	500	VPTH6,3X32Z	V600-8205202
6,3X38	Total	10	500	VPTH6,3X38Z	V600-8203604
6,3X45	Total	10	250	VPTH6,3X45Z	V600-8203603
6,3X50,8	Total	10	500	VPTH6,3X50,8Z	V600-8203602
6,3X60	Total	10	500	VPTH6,3X60Z	V600-8203601
6,3X65	Total	10	100	VPTH6,3X65Z	V600-8205208
6,3X70	Total	10	200	VPTH6,3X70Z	V600-8203600
6,3X80	Total	10	100	VPTH6,3X80Z	V600-8203599
6,3X100	Total	10	100	VPTH6,3X100Z	V600-8203598
6,3X120	Total	10	100	VPTH6,3X120Z	V600-8205555

Autres dimensions disponibles sur demande.

VIS AUTOPERÇEUSE TÊTE CYLINDRIQUE PHILLIPS



Dimensions ØxL (mm)	Filetage	Clé	Boîlage	Code	Référence
3,5X9,5	Total	PH2	500	VPTC3,5X9,5Z	V600-8203685
3,5X13	Total	PH2	500	VPTC3,5X13Z	V600-8205212
3,5X16	Total	PH2	500	VPTC3,5X16Z	V600-8203683
3,5X19	Total	PH2	500	VPTC3,5X19Z	V600-8203682
3,5X22	Total	PH2	500	VPTC3,5X22Z	V600-8203681
3,5X25	Total	PH2	500	VPTC3,5X25Z	V600-8203680
3,9X13	Total	PH2	500	VPTC3,9X13Z	V600-8203678
3,9X16	Total	PH2	500	VPTC3,9X16Z	V600-8203677
3,9X19	Total	PH2	500	VPTC3,9X19Z	V600-8203676
3,9X25	Total	PH2	500	VPTC3,9X25Z	V600-8205188
3,9X32	Total	PH2	500	VPTC3,9X32Z	V600-8203674
3,9X38	Total	PH2	500	VPTC3,9X38Z	V600-8203673
4,2X13	Total	PH2	500	VPTC4,2X13Z	V600-8203672
4,2X16	Total	PH2	500	VPTC4,2X16Z	V600-8203671

Dimensions ØxL (mm)	Filetage	Clé	Boîlage	Code	Référence
4,2X19	Total	PH2	500	VPTC4,2X19Z	V600-8203670
4,2X25	Total	PH2	500	VPTC4,2X25Z	V600-8203669
4,2X32	Total	PH2	500	VPTC4,2X32Z	V600-8203668
4,2X38	Total	PH2	500	VPTC4,2X38Z	V600-8203667
4,8X13	Total	PH2	500	VPTC4,8X13Z	V600-8203666
4,8X16	Total	PH2	500	VPTC4,8X16Z	V600-8203665
4,8X19	Total	PH2	500	VPTC4,8X19Z	V600-8203664
4,8X25	Total	PH2	500	VPTC4,8X25Z	V600-8205191
4,8X32	Total	PH2	500	VPTC4,8X32Z	V600-8203662
4,8X38	Total	PH2	500	VPTC4,8X38Z	V600-8203661
4,8X50,8	Total	PH2	500	VPTC4,8X50,8Z	V600-8203660
4,8X60	Total	PH2	250	VPTC4,8X60Z	V600-8203659
4,8X70	Total	PH2	250	VPTC4,8X70Z	V600-8203658

Autres dimensions disponibles sur demande.

VIS AUTOPERÇEUSE TÊTE FRAISÉE PHILLIPS



Dimensions ØxL (mm)	Filetage	Clé	Boîlage	Code	Référence
3,5X13	Total	PH2	500	VPTF3,5X13Z	V600-8205192
3,5X16	Total	PH2	500	VPTF3,5X16Z	V600-8203656
3,5X19	Total	PH2	500	VPTF3,5X19Z	V600-8203655
3,5X22	Total	PH2	500	VPTF3,5X22Z	V600-8203654
3,5X25	Total	PH2	500	VPTF3,5X25Z	V600-8203653
3,5X32	Total	PH2	500	VPTF3,5X32Z	V600-8205211
3,9X13	Total	PH2	500	VPTF3,9X13Z	V600-8203652
3,9X16	Total	PH2	500	VPTF3,9X16Z	V600-8203651
3,9X19	Total	PH2	500	VPTF3,9X19Z	V600-8203650
3,9X25	Total	PH2	500	VPTF3,9X25Z	V600-8205193
3,9X32	Total	PH2	500	VPTF3,9X32Z	V600-8203648
3,9X38	Total	PH2	500	VPTF3,9X38Z	V600-8205204
4,2X13	Total	PH2	500	VPTF4,2X13Z	V600-8205194
4,2X19	Total	PH2	500	VPTF4,2X19Z	V600-8203646

Dimensions ØxL (mm)	Filetage	Clé	Boîlage	Code	Référence
4,2X22	Total	PH2	500	VPTF4,2X22Z	V600-8203645
4,2X25	Total	PH2	500	VPTF4,2X25Z	V600-8203644
4,2X32	Total	PH2	500	VPTF4,2X32Z	V600-8203643
4,2X38	Total	PH2	500	VPTF4,2X38Z	V600-8203642
4,8X19	Total	PH2	500	VPTF4,8X19Z	V600-8203641
4,8X25	Total	PH2	500	VPTF4,8X25Z	V600-8203640
4,8X32	Total	PH2	500	VPTF4,8X32Z	V600-8203639
4,8X38	Total	PH2	500	VPTF4,8X38Z	V600-8203638
4,8X45	Total	PH2	500	VPTF4,8X45Z	V600-8203637
4,8X50	Total	PH2	500	VPTF4,8X50Z	V600-8203636
4,8X60	Total	PH2	500	VPTF4,8X60Z	V600-8205205
4,8X70	Total	PH2	500	VPTF4,8X70Z	V600-8205206
6,3X50,8	Total	PH3	250	VPTF6,3X50,8Z	V600-8203635
6,3X60	Total	PH3	250	VPTF6,3X60Z	V600-8203634

Autres dimensions disponibles sur demande.



Dimensions ØxL (mm)	Boîtage	Code	Référence
4X10	500	VMTRL4X10Z	V600-8203554
4X16	500	VMTRL4X16Z	V600-8203553
4X20	500	VMTRL4X20Z	V600-8203552
4X25	500	VMTRL4X25Z	V600-8203551
4X30	500	VMTRL4X30Z	V600-8203550
4X50	200	VMTRL4X50Z	V600-8203549
5X10	500	VMTRL5X10Z	V600-8203548
5X16	500	VMTRL5X16Z	V600-8203547
5X20	500	VMTRL5X20Z	V600-8203546
5X25	200	VMTRL5X25Z	V600-8203545
5X30	200	VMTRL5X30Z	V600-8203544
5X35	200	VMTRL5X35Z	V600-8203543
5X40	200	VMTRL5X40Z	V600-8203542
5X50	200	VMTRL5X50Z	V600-8203541
5X60	200	VMTRL5X60Z	V600-8203540
6x10	200	VMTRL6X10Z	V600-8205631
6X12	200	VMTRL6X12Z	V600-8203539
6X16	200	VMTRL6X16Z	V600-8203538
6X20	200	VMTRL6X20Z	V600-8203537
6X25	200	VMTRL6X25Z	V600-8203536

Dimensions ØxL (mm)	Boîtage	Code	Référence
6X30	200	VMTRL6X30Z	V600-8203535
6X35	200	VMTRL6X35Z	V600-8203534
6X40	100	VMTRL6X40Z	V600-8203533
6X50	100	VMTRL6X50Z	V600-8203532
6X60	100	VMTRL6X60Z	V600-8203531
6X80	100	VMTRL6X80Z	V600-8205210
6X100	100	VMTRL6X100Z	V600-8203530
8X16	200	VMTRL8X16Z	V600-8203529
8X20	100	VMTRL8X20Z	V600-8203528
8X25	100	VMTRL8X25Z	V600-8203527
8X30	100	VMTRL8X30Z	V600-8203526
8x35	200	VMTRL8X35Z	V600-8205630
8X40	100	VMTRL8X40Z	V600-8203525
8X50	100	VMTRL8X50Z	V600-8203524
8X60	100	VMTRL8X60Z	V600-8203523
8X100	100	VMTRL8X100Z	V600-8203522
10X20	100	VMTRL10X20Z	V600-8205209
10x50	100	VMTRL10X50Z	V600-8205629
10x60	50	VMTRL10X60Z	V600-8205628

Autres dimensions disponibles sur demande.



Dimensions ØxL (mm)	Boîtage	Code	Référence
5x25	200	TIR5X25Z	V600-8205815
5X30	200	TIR5X30Z	V600-8203597
5X40	200	TIR5X40Z	V600-8203596
5X50	200	TIR5X50Z	V600-8203595
5x60	200	TIR5X60Z	V600-8205814
6X25	200	TIR6X25Z	V600-8203594
6X30	200	TIR6X30Z	V600-8203593
6X35	200	TIR6X35Z	V600-8203592
6X40	200	TIR6X40Z	V600-8203591
6X50	200	TIR6X50Z	V600-8203590
6X60	200	TIR6X60Z	V600-8203589
6X70	200	TIR6X70Z	V600-8203588
6X80	200	TIR6X80Z	V600-8203587
6X90	100	TIR6X90Z	V600-8203586
6x100	100	TIR6X100Z	V600-8205813
7X40	100	TIR7X40Z	V600-8203585
7X50	100	TIR7X50Z	V600-8203584
7X60	100	TIR7X60Z	V600-8203583
7X70	100	TIR7X70Z	V600-8203582
8x25	200	TIR8X25Z	V600-8205812
8X30	200	TIR8X30Z	V600-8203581
8X40	200	TIR8X40Z	V600-8203580
8X45	200	TIR8X45Z	V600-8203579
8X50	200	TIR8X50Z	V600-8203578
8X60	200	TIR8X60Z	V600-8203577
8X70	200	TIR8X70Z	V600-8203576
8X80	200	TIR8X80Z	V600-8203575
8X90	100	TIR8X90Z	V600-8203574
8X100	100	TIR8X100Z	V600-8203573
8X120	100	TIR8X120Z	V600-8203572

Dimensions ØxL (mm)	Boîtage	Code	Référence
8x140	50	TIR8X140Z	V600-8205811
8x160	50	TIR8X160Z	V600-8205810
10x30	200	TIR10X30Z	V600-8205809
10X40	100	TIR10X40Z	V600-8203571
10X50	100	TIR10X50Z	V600-8203570
10X60	100	TIR10X60Z	V600-8203569
10X70	100	TIR10X70Z	V600-8203568
10X80	100	TIR10X80Z	V600-8203567
10X90	100	TIR10X90Z	V600-8203566
10X100	100	TIR10X100Z	V600-8203565
10X120	50	TIR10X120Z	V600-8203564
10X140	50	TIR10X140Z	V600-8203563
10X160	50	TIR10X160Z	V600-8203562
10X180	50	TIR10X180Z	V600-8203561
10x200	50	TIR10X200Z	V600-8205808
10x240	25	TIR10X240Z	V600-8205807
12x50	100	TIR12X50Z	V600-8205806
12x60	100	TIR12X60Z	V600-8205805
12X80	50	TIR12X80Z	V600-8203560
12X100	50	TIR12X100Z	V600-8203559
12X120	50	TIR12X120Z	V600-8203558
12X140	50	TIR12X140Z	V600-8203557
12X160	25	TIR12X160Z	V600-8203556
12X180	25	TIR12X180Z	V600-8203555
12x200	25	TIR12X200Z	V600-8205804
12x260	25	TIR12X260Z	V600-8205803
12x280	25	TIR12X280Z	V600-8205802
12x300	25	TIR12X300Z	V600-8205801
16x120	25	TIR16X120Z	V600-8205800

Autres dimensions disponibles sur demande.

VIS À BOIS À TÊTE RONDE FENDUE

Anfitec



Dimensions ØxL (mm)	Filetage	Boîlage	Code	Référence
4x20	Partiel	200	VBTRF4X20ZPF	V600-8205627
4x25	Partiel	200	VBTRF4X25ZPF	V600-8205626
4x30	Partiel	200	VBTRF4X30ZPF	V600-8205625
5x40	Partiel	200	VBTRF5X40ZPF	V600-8205624

Dimensions ØxL (mm)	Filetage	Boîlage	Code	Référence
6x25	Partiel	200	VBTRF6X25ZPF	V600-8205623
6x30	Partiel	200	VBTRF6X30ZPF	V600-8205622
6x50	Partiel	200	VBTRF5X50ZPF	V600-8205621

VIS SANS TÊTE À SIX PANS CREUX ZG

Anfitec

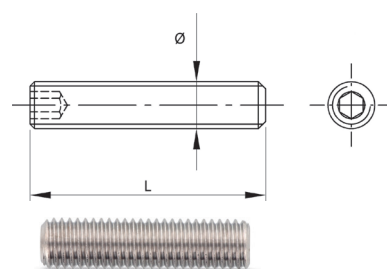

Dimensions ØxL (mm)	Filetage	Boîlage	Code	Référence
3x5	Total	200	STHCPLA3X5Z	V600-8205924
3x6	Total	200	STHCPLA3X6EFZ	V600-8203839
3x10	Total	200	STHCPLA3X10EFZ	V600-8203837
3x12	Total	200	STHCPLA3X12Z	V600-8205921
4x6	Total	200	STHCPLA4X6Z	V600-8205920
4x8	Total	200	STHCPLA4X8Z	V600-8205919
4x12	Total	200	STHCPLA4X12Z	V600-8205918
4x16	Total	200	STHCPLA4X16Z	V600-8205917
4x25	Total	200	STHCPLA4X25EFZ	V600-8205916
5x6	Total	200	STHCPLA5X6Z	V600-8205915
5x10	Total	200	STHCPLA5X10Z	V600-8205914
5x16	Total	200	STHCPLA5X16Z	V600-8205913
5x5	Total	200	STHCPLA5X5EFZ	V600-8205912
6x6	Total	200	STHCPLA6X6Z	V600-8205911
6x10	Total	200	STHCPLA6X10Z	V600-8205910
6x12	Total	200	STHCPLA6X12EFZ	V600-8205909
6x16	Total	200	STHCPLA6X16Z	V600-8205908
6x20	Total	200	STHCPLA6X20Z	V600-8205907

Dimensions ØxL (mm)	Filetage	Boîlage	Code	Référence
6x25	Total	200	STHCPLA6X25Z	V600-8205906
6x30	Total	200	STHCPLA6X30Z	V600-8205905
6x35	Total	100	STHCPLA6X35Z	V600-8205904
6x40	Total	100	STHCPLA6X40Z	V600-8205903
6x60	Total	100	STHCPLA6X60EFZ	V600-8205902
8x8	Total	100	STHCPLA8X8EFZ	V600-8205901
8x10	Total	200	STHCPLA8X10Z	V600-8205900
8x16	Total	200	STHCPLA8X16Z	V600-8205899
8x30	Total	200	STHCPLA8X30Z	V600-8205898
8x50	Total	100	STHCPLA8X50Z	V600-8205897
8x60	Total	100	STHCPLA8X60Z	V600-8205896
10x10	Total	200	STHCPLA10X10EFZ	V600-8205895
10x20	Total	200	STHCPLA10X20Z	V600-8205894
10x35	Total	100	STHCPLA10X35Z	V600-8205893
12x20	Total	100	STHCPLA12X20EFZ	V600-8203777
12x25	Total	100	STHCPLA12X25Z	V600-8205891
12x45	Total	100	STHCPLA12X45EFZ	V600-8205890
16x30	Total	100	STHCPLA16X30EFZ	V600-8203767



Dimensions ØxL (mm)	Boîtage	Code	Référence
5x20	500	BTRCC5X20Z	V600-8205831
5x30	500	BTRCC5X30Z	V600-8205830
5x35	200	BTRCC5X35Z	V600-8205829
5x40	200	BTRCC5X40Z	V600-8205828
5x70	200	BTRCC5X70Z	V600-8205827
6X16	200	BTRCC6X16Z	V600-8204265
6X20	200	BTRCC6X20Z	V600-8204264
6X30	200	BTRCC6X30Z	V600-8204262
6X35	200	BTRCC6X35Z	V600-8204263
6X40	200	BTRCC6X40Z	V600-8204260
6X45	200	BTRCC6X45Z	V600-8204261
6X50	200	BTRCC6X50Z	V600-8204259
6X60	200	BTRCC6X60Z	V600-8204258
6X65	200	BTRCC6X65Z	V600-8204256
6X70	200	BTRCC6X70Z	V600-8204257
6X80	200	BTRCC6X80Z	V600-8204255
6x100	100	BTRCC6X100Z	V600-8205826
8X16	200	BTRCC8X16Z	V600-8204254
8X25	200	BTRCC8X25Z	V600-8204252
8X30	200	BTRCC8X30Z	V600-8204253
8X35	200	BTRCC8X35Z	V600-8204251
8X40	200	BTRCC8X40Z	V600-8204250
8X50	200	BTRCC8X50Z	V600-8204248
8X60	200	BTRCC8X60Z	V600-8204249
8X70	200	BTRCC8X70Z	V600-8204247
8X80	200	BTRCC8X80Z	V600-8204246
8X90	100	BTRCC8X90Z	V600-8204245

Dimensions ØxL (mm)	Boîtage	Code	Référence
8X100	100	BTRCC8X100Z	V600-8204243
8X110	100	BTRCC8X110Z	V600-8204242
8X120	100	BTRCC8X120Z	V600-8204244
10X30	200	BTRCC10X30Z	V600-8204240
10x40	100	BTRCC10X40Z	V600-8205825
10X50	100	BTRCC10X50Z	V600-8204239
10X60	100	BTRCC10X60Z	V600-8204241
10X70	100	BTRCC10X70Z	V600-8204238
10X80	100	BTRCC10X80Z	V600-8204237
10x90	100	BTRCC10X90Z	V600-8205824
10X100	100	BTRCC10X100Z	V600-8204236
10X120	50	BTRCC10X120Z	V600-8204235
10X140	50	BTRCC10X140Z	V600-8204234
10X160	50	BTRCC10X160Z	V600-8204233
10X180	50	BTRCC10X180Z	V600-8204232
10x240	25	BTRCC10X240Z	V600-8209178
12x50	100	BTRCC12X50Z	V600-8205823
12x70	50	BTRCC12X70Z	V600-8205822
12x80	50	BTRCC12X80Z	V600-8205821
12x90	50	BTRCC12X90Z	V600-8205820
12X100	50	BTRCC12X100Z	V600-8204231
12x120	50	BTRCC12X120Z	V600-8205819
12x160	25	BTRCC12X160Z	V600-8205818
12X180	25	BTRCC12X180Z	V600-8204230
12x250	25	BTRCC12X250Z	V600-8205817
16x120	25	BTRCC16X120Z	V600-8205816

Autres dimensions disponibles sur demande.

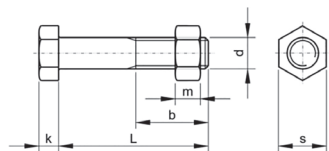

Dimensions ØxL (mm)	Boîtage	Code	Référence
6x30	500	BTH6X30.6Z	V600-8205888
6x40	200	BTH6X40.6Z	V600-8205887
6x50	200	BTH6X50.6Z	V600-8205886
6x60	200	BTH6X60.6Z	V600-8205885
6x70	200	BTH6X70.6Z	V600-8205884
8x16	200	BTH8X16.6Z	V600-8205883
8x20	200	BTH8X20.6Z	V600-8205882
8x25	200	BTH8X25.6Z	V600-8205881
8x30	200	BTH8X30.6Z	V600-8205880
8x35	200	BTH8X35.6Z	V600-8205879
8x40	200	BTH8X40.6Z	V600-8205878
8x50	200	BTH8X50.6Z	V600-8205877
8x60	200	BTH8X60.6Z	V600-8205876
10x20	200	BTH10X20.6Z	V600-8205875
10x25	200	BTH10X25.6Z	V600-8205874
10x30	200	BTH10X30.6Z	V600-8205873
10x40	100	BTH10X40.6Z	V600-8205872
10x50	100	BTH10X50.6Z	V600-8205871
10x60	100	BTH10X60.6Z	V600-8205870
10x70	100	BTH10X70.6Z	V600-8205869
10x80	100	BTH10X80.6Z	V600-8205868
12x25	100	BTH12X25.6Z	V600-8205867
12x30	100	BTH12X30.6Z	V600-8205866
12x40	100	BTH12X40.6Z	V600-8205865
12x50	100	BTH12X50.6Z	V600-8205864
12x55	100	BTH12X55.6Z	V600-8205863
12x60	100	BTH12X60.6Z	V600-8205862
12x70	50	BTH12X70.6Z	V600-8205861
12x80	50	BTH12X80.6Z	V600-8205860

Dimensions ØxL (mm)	Boîtage	Code	Référence
12x130	50	BTH12X130.6Z	V600-8205859
14x30	100	BTH14X30.6Z	V600-8205858
14x35	100	BTH14X35.6Z	V600-8205857
14x40	100	BTH14X40.6Z	V600-8205856
14x45	50	BTH14X45.6Z	V600-8205855
14x50	50	BTH14X50.6Z	V600-8205854
14x60	50	BTH14X60.6Z	V600-8205853
14x80	50	BTH14X80.6Z	V600-8205852
14x100	50	BTH14X100.6Z	V600-8205851
16x30	50	BTH16X30.6Z	V600-8205850
16x40	50	BTH16X40.6Z	V600-8205849
16x50	50	BTH16X50.6Z	V600-8205848
16x60	50	BTH16X60.6Z	V600-8205847
16x70	25	BTH16X70.6Z	V600-8205846
16x80	25	BTH16X80.6Z	V600-8205845
16x90	25	BTH16X90.6Z	V600-8205844
16x100	25	BTH16X100.6Z	V600-8205843
16x110	25	BTH16110.6Z	V600-8205842
16x160	25	BTH16X160.6Z	V600-8205841
20x50	25	BTH20X50.6Z	V600-8205840
20x60	25	BTH20X60.6Z	V600-8205839
20x70	25	BTH20X70.6Z	V600-8205838
20x80	25	BTH20X80.6Z	V600-8205837
20x90	25	BTH20X90.6Z	V600-8205836
20x100	25	BTH20X100.6Z	V600-8205835
20x120	25	BTH20X120.6Z	V600-8205834
24x90	10	BTH24X90.6Z	V600-8205833
24x100	10	BTH24X100.6Z	V600-8205832

GOUPILLE CYLINDRIQUE FENDUE



DIN
94

ISO
1234



Dimensions ØxL (mm)	Boîtage	Code	Référence
1X10	1000	GOFDU1X10Z	V600-8205321
1,2X12	1000	GOFDU1,2X12Z	V600-8205320
2,5X14	500	GOFDU2,5X14Z	V600-8205319
2,5X22	500	GOFDU2,5X22Z	V600-8205318
3,2X16	250	GOFDU3,2X16Z	V600-8205317
3,2X36	250	GOFDU3,2X36Z	V600-8205316
3,5X50	250	GOFDU3,5X50Z	V600-8205315
4X22	500	GOFDU4X22Z	V600-8205314
4X25	250	GOFDU4X25Z	V600-8205313
4X36	250	GOFDU4X36Z	V600-8205312
4X45	250	GOFDU4X45Z	V600-8205311
4X56	200	GOFDU4X56Z	V600-8205310
4X71	200	GOFDU4X71Z	V600-8205309
4X80	200	GOFDU4X80Z	V600-8205308
4,5X50	200	GOFDU4,5X50Z	V600-8205307
5X20	250	GOFDU5X20Z	V600-8205306
5X36	200	GOFDU5X36Z	V600-8205305

Dimensions ØxL (mm)	Boîtage	Code	Référence
5X40	200	GOFDU5X40Z	V600-8205304
5X45	200	GOFDU5X45Z	V600-8205303
5X71	100	GOFDU5X71Z	V600-8205302
5X100	100	GOFDU5X100Z	V600-8205301
6,3X45	100	GOFDU6,3X45Z	V600-8205300
6,3X56	100	GOFDU6,3X56Z	V600-8205299
6,3X63	100	GOFDU6,3X63Z	V600-8205298
6,3X90	100	GOFDU6,3X90Z	V600-8205297
6,3X100	100	GOFDU6,3X100Z	V600-8205296
8X56	100	GOFDU8X56Z	V600-8205295
8X71	50	GOFDU8X71Z	V600-8205294
8X90	50	GOFDU8X90Z	V600-8205293
8X100	50	GOFDU8X100Z	V600-8205292
10X125	25	GOFDU10X125Z	V600-8205291
13X112	25	GOFDU13X112Z	V600-8205290
13X125	25	GOFDU13X125Z	V600-8205289

GOUPILLE CLIP

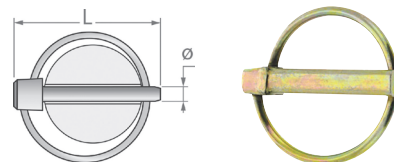

Dimensions ØxL (mm)	Boîtage	Code	Référence
4,5X42	25	GOCLIP4,5X42ZBI	V600-8204127
6X42	25	GOCLIP6X42ZBI	V600-8204126
8x42	25	GOCLIP8X42ZBI	V600-8204125

Dimensions ØxL (mm)	Boîtage	Code	Référence
10X40	10	GOCLIP10X40ZBI	V600-8205187
11X46	10	GOCLIP11X46ZBI	V600-8204123

Autres dimensions disponibles sur demande.

Habillez votre magasin avec tout l'équipement GISS spécial visserie !



Rayonnage à tablettes tôlées



Bacs à bec

Pour un devis, contactez votre agence.



VIS TÊTE HEXAGONALE À EMBASSE LISSE



Dimensions ØxL (mm)	Filetage	Boîtage	Code	Référence
12x40	Partiel	100	THE12X40PF8Z	V600-8207887
12x50	Partiel	100	THE12X50PF8Z	V600-8207886



VIS À BOIS À TÊTE FRAISÉE À EMPREINTE CRUCIFORME POZIDRIV



Dimensions ØxL (mm)	Filetage	Boîtage	Code	Référence
4x20	Total	200	VBTF4X20EFPOZZJ	V600-8208750



VIS POUR AGGLOMÉRÉE À TÊTE CYLINDRIQUE BOMBÉE À EMPREINTE CRUCIFORME



Dimensions ØxL (mm)	Filetage	Boîtage	Code	Référence
3x12	Total	200	VATF3X12EFPOZZBI	V600-8205585
3x25	Total	200	VATF3X25EFPOZZBI	V600-8205584
3x40	Total	1000	VATF3X40EFPOZZBI	V600-8205583
3,5x16	Total	200	VATF3,5X16EFPOZZBI	V600-8205582
3,5x20	Total	200	VATF3,5X20EFPOZZBI	V600-8205581
4x16	Total	200	VATF4X16EFPOZZBI	V600-8205580
4x20	Total	200	VATF4X20EFPOZZBI	V600-8208752
4x35	Total	200	VATF4X35EFPOZZBI	V600-8205579
4x45	Total	200	VATF4X45EFPOZZBI	V600-8205578
4x50	Total	200	VATF4X50EFPOZZBI	V600-8205577
4x60	Total	200	VATF4X60EFPOZZBI	V600-8205576
4,5x20	Total	200	VATF4,5X20EFPOZZBI	V600-8205575
4,5x25	Total	200	VATF4,5X25EFPOZZBI	V600-8205574

Dimensions ØxL (mm)	Filetage	Boîtage	Code	Référence
4,5x40	Total	200	VATF4,5X40EFPOZZBI	V600-8205573
5x20	Total	200	VATF5X19EFPOZZBI	V600-8205572
5x25	Total	200	VATF5X25EFPOZZBI	V600-8205571
5x30	Total	200	VATF5X30EFPOZZBI	V600-8208751
5x40	Total	200	VATF5X40EFPOZZBI	V600-8205570
5x60	Total	200	VATF5X60PPFOZZBI	V600-8205569
5x70	Total	200	VATF5X70EFPOZZBI	V600-8205568
5x80	Total	200	VATF5X80EFPOZZBI	V600-8205567
6x30	Total	200	VATF6X30EFPOZZBI	V600-8205566
6x40	Total	200	VATF6X40PPFOZZBI	V600-8205565
6x50	Total	200	VATF6X50EFPOZZBI	V600-8205564
6x70	Total	200	VATF6X70EFPOZZBI	V600-8205563
6x80	Total	200	VATF6X80EFPOZZBI	V600-8205562



VIS POUR AGGLOMÉRÉ TÊTE FRAISÉE POZIDRIV



Dimensions ØxL (mm)	Filetage	Clé	Boîtage	Code	Référence
3X16	Total	PZ1	200	VATF3X16EFPOZZB	V600-8203739
3X20	Total	PZ1	200	VATF3X20EFPOZZB	V600-8203738
3X30	Total	PZ1	200	VATF3X30EFPOZZB	V600-8203737
3X40	Total	PZ1	500	VATF3X40EFPOZZB	V600-8203736
3,5X16	Total	PZ2	200	VATF3,5X16EFPOZZB	V600-8203735
3,5X20	Total	PZ2	200	VATF3,5X20EFPOZZB	V600-8203734
3,5X25	Total	PZ2	200	VATF3,5X25EFPOZZB	V600-8203733
3,5X30	Total	PZ2	200	VATF3,5X30EFPOZZB	V600-8203732
3,5X35	Total	PZ2	200	VATF3,5X35EFPOZZB	V600-8203731
3,5X40	Total	PZ2	200	VATF3,5X40EFPOZZB	V600-8203730
3,5X50	Total	PZ2	500	VATF3,5X50EFPOZZB	V600-8203729
4X20	Total	PZ2	200	VATF4X20EFPOZZB	V600-8203728
4X25	Total	PZ2	200	VATF4X25EFPOZZB	V600-8203727
4X30	Total	PZ2	200	VATF4X30EFPOZZB	V600-8203726
4X35	Total	PZ2	200	VATF4X35EFPOZZB	V600-8203725
4X40	Total	PZ2	200	VATF4X40EFPOZZB	V600-8203724
4X45	Total	PZ2	200	VATF4X45EFPOZZB	V600-8203723
4X50	Total	PZ2	200	VATF4X50EFPOZZB	V600-8203722
4X60	Total	PZ2	200	VATF4X60EFPOZZB	V600-8203721
4X70	Partiel	PZ2	200	VATF4X70PFPOZZB	V600-8203720
4,5X30	Total	PZ2	200	VATF4,5X30EFPOZZB	V600-8203719

Dimensions ØxL (mm)	Filetage	Clé	Boîtage	Code	Référence
4,5X35	Total	PZ2	200	VATF4,5X35EFPOZZB	V600-8203718
4,5X40	Total	PZ2	200	VATF4,5X40EFPOZZB	V600-8203717
4,5X45	Total	PZ2	200	VATF4,5X45EFPOZZB	V600-8203716
4,5X50	Total	PZ2	200	VATF4,5X50EFPOZZB	V600-8203715
4,5X60	Total	PZ2	200	VATF4,5X60EFPOZZB	V600-8203714
4,5X70	Partiel	PZ2	200	VATF4,5X70PFPOZZB	V600-8203713
5X30	Total	PZ2	200	VATF5X30EFPOZZB	V600-8203712
5X40	Total	PZ2	200	VATF5X40EFPOZZB	V600-8203711
5X50	Total	PZ2	200	VATF5X50EFPOZZB	V600-8203710
5X60	Total	PZ2	200	VATF5X60EFPOZZB	V600-8203709
5X70	Partiel	PZ2	200	VATF5X70PFPOZZB	V600-8203708
5X80	Partiel	PZ2	200	VATF5X80PFPOZZB	V600-8203707
5X100	Partiel	PZ2	200	VATF5X100PFPOZZB	V600-8203706
6X30	Total	PZ3	200	VATF6X30EFPOZZB	V600-8203705
6X40	Total	PZ3	200	VATF6X40EFPOZZB	V600-8203704
6X50	Total	PZ3	200	VATF6X50EFPOZZB	V600-8203703
6X60	Total	PZ3	200	VATF6X60EFPOZZB	V600-8203702
6X70	Total	PZ3	200	VATF6X70EFPOZZB	V600-8203701
6X80	Partiel	PZ3	200	VATF6X80PFPOZZB	V600-8203700
6X100	Partiel	PZ3	200	VATF6X100PFPOZZB	V600-8203699
6X120	Partiel	PZ3	200	VATF6X120PFPOZZB	V600-8203698

Autres dimensions disponibles sur demande.

ÉCROU HEXAGONAL ACIER BRUT CLASSE 8

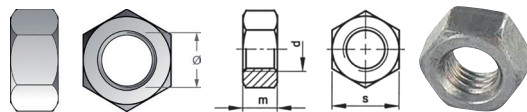

Ø (mm)	Clé	Boîlage	Code	Référence
2,5	5	250	ECHU2,5BR.8	V600-8208021
3	5,5	250	ECHU3BR.8	V600-8208809
4	7	250	ECHU4BR.8	V600-8208020
5	8	250	ECHU5BR.8	V600-8208019
6	10	250	ECHU6BR.8	V600-8208018
8	13	250	ECHU8BR.8	V600-8208017
10	16	250	ECHU10BR.8	V600-8208016

Ø (mm)	Clé	Boîlage	Code	Référence
12	19	100	ECHU12BR.8	V600-8208015
14	22	100	ECHU14BR.8	V600-8208014
16	24	100	ECHU16BR.8	V600-8208808
18	27	50	ECHU18BR.8	V600-8208807
22	34	25	ECHU22BR.8	V600-8208013
24	36	25	ECHU24BR.8	V600-8208806
45	70	4	ECHU45BR.8	V600-8208012

ÉCROU HEXAGONAL ACIER BRUT CLASSE 10



Ø (mm)	Clé	Boîlage	Code	Référence
8	13	250	ECHU8BR.10	V600-8207876
10	16	250	ECHU10BR.10	V600-8207875
12	19	100	ECHU12BR.10	V600-8207874
14	22	100	ECHU14BR.10	V600-8207873
16	24	100	ECHU16BR.10	V600-8207872

Ø (mm)	Clé	Boîlage	Code	Référence
20	30	50	ECHU20BR.10	V600-8207871
24	36	25	ECHU24BR.10	V600-8207870
27	41	25	ECHU27BR.10	V600-8207869
30	46	25	ECHU30BR.10	V600-8207868

ÉCROU HEXAGONAL ACIER BRUT CLASSE 12

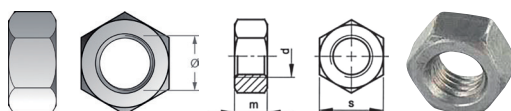

Ø (mm)	Clé	Boîlage	Code	Référence
10	16	250	ECHU10BR.12	V600-8207867
12	19	100	ECHU12BR.12	V600-8207866
16	24	100	ECHU16BR.12	V600-8207865

Ø (mm)	Clé	Boîlage	Code	Référence
20	30	50	ECHU20BR.12	V600-8207864
24	36	25	ECHU24BR.12	V600-8207863

ÉCROU HEXAGONAL À SOUDER

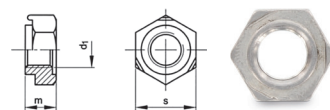

Ø (mm)	Clé	Boîlage	Code	Référence
4	7	1000	ECHUSOUD4BR	V600-8205769
5	8	1000	ECHUSOUD5BR	V600-8205768
6	10	1000	ECHUSOUD6BR	V600-8205767
8	13	1000	ECHUSOUD8BR	V600-8205766

Ø (mm)	Clé	Boîlage	Code	Référence
10	16	500	ECHUSOUD10BR	V600-8205765
12	19	100	ECHUSOUD12BR	V600-8205764
14	22	100	ECHUSOUD14BR	V600-8205763
16	24	100	ECHUSOUD16BR	V600-8205762

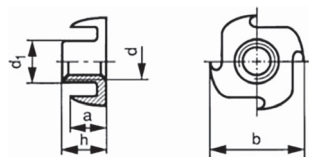

ÉCROU À ENFONCER POUR BOIS



Ø (mm)	Boîtage	Code	Référence
6	500	ECHUGRIF6BR	V600-8205760
8	500	ECHUGRIF8BR	V600-8205759
10	250	ECHUGRIF10BR	V600-8205758

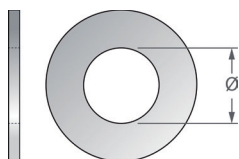

RONDELLE PLATE TYPE M



NFE
25-513

Ø (mm)	Dimensions (mm)	Boîtage	Code	Référence
M4	4,3x10x0,8	500	RONMU4BR	V600-8205422
M5	5,3x12x1	500	RONMU5BR	V600-8205421
M6	6,4x14x1,2	500	RONMU6BR	V600-8205420
M8	8,4x18x1,5	250	RONMU8BR	V600-8205419
M10	10,5x22x2	200	RONMU10BR	V600-8205418
M12	13x27x2,5	200	RONMU12BR	V600-8205417
M14	15x30x2,5	200	RONMU14BR	V600-8205416
M16	17x32x3	100	RONMU16BR	V600-8205415
M18	19x36x3	100	RONMU18BR	V600-8205414
M21	21x40x3	100	RONMU21BR	V600-8205413

Ø (mm)	Dimensions (mm)	Boîtage	Code	Référence
M22	23x45x3	100	RONMU22BR	V600-8205412
M24	25x50x4	100	RONMU24BR	V600-8205411
M27	28x55x4	100	RONMU27BR	V600-8205410
M31	31x60x4	100	RONMU31BR	V600-8205409
M33	34x65x5	100	RONMU33BR	V600-8205408
M36	37x70x5	100	RONMU36BR	V600-8205407
M39	40x75x6	100	RONMU39BR	V600-8205406
M45	46x85x7	100	RONMU45BR	V600-8205405
M48	50x90x7	50	RONMU48BR	V600-8205404

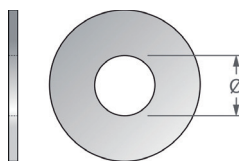

RONDELLE PLATE TYPE L



NFE
25-513

Ø (mm)	Dimensions (mm)	Boîtage	Code	Référence
M3	3,2x12x0,8	500	RONLU3BR	V600-8205399
M4	4,3x14x0,8	500	RONLU4BR	V600-8205398
M5	5,3x16x1	500	RONLU5BR	V600-8205397
M6	6,4x18x1,2	500	RONLU6BR	V600-8205396

Ø (mm)	Dimensions (mm)	Boîtage	Code	Référence
M8	8,4x22x1,5	250	RONLU8BR	V600-8205395
M10	10,5x27x2	200	RONLU10BR	V600-8205394
M13	13x32x2,5	200	RONLU13BR	V600-8205393
M17	17x40x3	100	RONLU17BR	V600-8205392

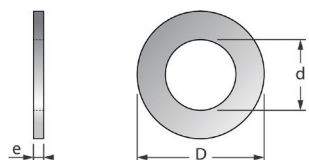

RONDELLE PLATE TYPE Z



NFE
25-513

Ø (mm)	Dimensions (mm)	Boîtage	Code	Référence
M3	3,2x6x0,8	500	RONZ3BR	V600-8205435
M4	4,3x8x0,8	500	RONZ4BR	V600-8205434
M5	5,3x10x1	500	RONZ5BR	V600-8205433
M6	6,4x12x1,2	250	RONZ6BR	V600-8205432
M8	8,4x16x1,5	250	RONZ8BR	V600-8205431

Ø (mm)	Dimensions (mm)	Boîtage	Code	Référence
M10	10,5x20x2	200	RONZ10BR	V600-8205430
M12	13x24x2,5	150	RONZ12BR	V600-8205429
M14	15x27x2,5	100	RONZ14BR	V600-8205428
M18	19x32x3	100	RONZ18BR	V600-8205427
M20	21x36x3	100	RONZ20BR	V600-8205426

TIGE FILETÉE 1M



Ø (mm)	Longueur (mm)	Code	Référence
2	1000	TF1M2BR.4	V600-8205753
3	1000	TF1M3BR.4	V600-8205752
4	1000	TF1M4BR.8	V600-8205749
18	1000	TF1M18BR.4	V600-8205751

Ø (mm)	Longueur (mm)	Code	Référence
22	1000	TF1M22BR.8	V600-8205747
27	1000	TF1M27BR.4	V600-8205750
30	1000	TF1M30BR.8	V600-8205745

VIS CHC - TÊTE CYLINDRIQUE HEXAGONALE CREUSE

12.9

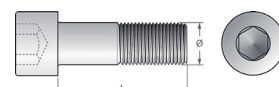

Dimensions ØxL (mm)	Filetage	Clé	Boîtage	Code	Référence
2,5X10	Total	2	100	CHC2,5X10EF12	V600-8203447
3X10	Total	2.5	200	CHC3X10EF12	V600-8203446
3X12	Total	2.5	200	CHC3X12EF12	V600-8203445
3X16	Total	2.5	200	CHC3X16EF12	V600-8203444
3X20	Total	2.5	200	CHC3X20EF12	V600-8203443
3X25	Partiel	2.5	200	CHC3X25PF12	V600-8203442
3X30	Partiel	2.5	200	CHC3X30PF12	V600-8203441
3X35	Partiel	2.5	200	CHC3X35PF12	V600-8203440
3X40	Partiel	2.5	200	CHC3X40PF12	V600-8203439
3X50	Partiel	2.5	200	CHC3X50PF12	V600-8203438
3X60	Partiel	2.5	200	CHC3X60PF12	V600-8203437
4X8	Total	3	200	CHC4X8EF12	V600-8203436
4X10	Total	3	200	CHC4X10EF12	V600-8203435
4X12	Total	3	200	CHC4X12EF12	V600-8203434
4X16	Total	3	200	CHC4X16EF12	V600-8203433
4X20	Total	3	200	CHC4X20EF12	V600-8203432
4X25	Total	3	200	CHC4X25EF12	V600-8203431
4X30	Partiel	3	200	CHC4X30PF12	V600-8203430
4X35	Partiel	3	200	CHC4X35PF12	V600-8203429
4X40	Partiel	3	200	CHC4X40PF12	V600-8203428
4X50	Partiel	3	200	CHC4X50PF12	V600-8203427
4X60	Partiel	3	200	CHC4X60PF12	V600-8203426
5X10	Total	4	200	CHC5X10EF12	V600-8203425
5X12	Total	4	200	CHC5X12EF12	V600-8203424
5X16	Total	4	200	CHC5X16EF12	V600-8203423
5X20	Total	4	200	CHC5X20EF12	V600-8203422
5X25	Total	4	200	CHC5X25EF12	V600-8203421
5X30	Partiel	4	200	CHC5X30PF12	V600-8203420
5X35	Partiel	4	200	CHC5X35PF12	V600-8203419
5X40	Partiel	4	200	CHC5X40PF12	V600-8203418
5X45	Partiel	4	200	CHC5X45PF12	V600-8203417
5X50	Partiel	4	200	CHC5X50PF12	V600-8203416
5X60	Partiel	4	200	CHC5X60PF12	V600-8203415
5X70	Partiel	4	200	CHC5X70PF12	V600-8203414
5X80	Partiel	4	200	CHC5X80PF12	V600-8203413
6X10	Partiel	5	200	CHC6X10PF12	V600-8203412
6X12	Total	5	200	CHC6X12EF12	V600-8203411
6X16	Total	5	200	CHC6X16EF12	V600-8203410
6X20	Total	5	200	CHC6X20EF12	V600-8203409
6X25	Total	5	200	CHC6X25EF12	V600-8203408
6X30	Total	5	200	CHC6X30EF12	V600-8203407
6X35	Partiel	5	200	CHC6X35PF12	V600-8209208
6X40	Partiel	5	200	CHC6X40PF12	V600-8203405
6X45	Partiel	5	200	CHC6X45PF12	V600-8203404
6X50	Partiel	5	200	CHC6X50PF12	V600-8203403
6X60	Partiel	5	200	CHC6X60PF12	V600-8203402

Dimensions ØxL (mm)	Filetage	Clé	Boîtage	Code	Référence
6X70	Partiel	5	200	CHC6X70PF12	V600-8203401
6X80	Partiel	5	200	CHC6X80PF12	V600-8203400
6X90	Partiel	5	100	CHC6X90PF12	V600-8203399
8X10	Total	6	200	CHC8X10EF12	V600-8203398
8X16	Total	6	200	CHC8X16EF12	V600-8203397
8X20	Total	6	200	CHC8X20EF12	V600-8203396
8X25	Total	6	200	CHC8X25EF12	V600-8203395
8X30	Total	6	200	CHC8X30EF12	V600-8203394
8X35	Total	6	200	CHC8X35EF12	V600-8203393
8X40	Partiel	6	200	CHC8X40PF12	V600-8203392
8X45	Partiel	6	200	CHC8X45PF12	V600-8203391
8X50	Partiel	6	200	CHC8X50PF12	V600-8203390
8X55	Partiel	6	200	CHC8X55PF12	V600-8203389
8X60	Partiel	6	200	CHC8X60PF12	V600-8203388
8X70	Partiel	6	200	CHC8X70PF12	V600-8203387
8X80	Partiel	6	200	CHC8X80PF12	V600-8203386
8X90	Partiel	6	100	CHC8X90PF12	V600-8203385
8X100	Partiel	6	100	CHC8X100PF12	V600-8203384
10X20	Total	8	200	CHC10X20EF12	V600-8203383
10X25	Total	8	200	CHC10X25EF12	V600-8203382
10X30	Total	8	200	CHC10X30EF12	V600-8203381
10X35	Total	8	100	CHC10X35EF12	V600-8203380
10X40	Total	8	100	CHC10X40EF12	V600-8203379
10X45	Partiel	8	100	CHC10X45PF12	V600-8203378
10X50	Partiel	8	100	CHC10X50PF12	V600-8203377
10X60	Partiel	8	100	CHC10X60PF12	V600-8203376
10X70	Partiel	8	100	CHC10X70PF12	V600-8203375
10X80	Partiel	8	100	CHC10X80PF12	V600-8203374
10X90	Partiel	8	100	CHC10X90PF12	V600-8203373
10X100	Partiel	8	50	CHC10X100PF12	V600-8203372
12X30	Total	10	100	CHC12X30EF12	V600-8203371
12X35	Total	10	100	CHC12X35EF12	V600-8203370
12X40	Total	10	100	CHC12X40EF12	V600-8203369
12X50	Total	10	100	CHC12X50EF12	V600-8203368
12X60	Partiel	10	100	CHC12X60PF12	V600-8203367
12X70	Partiel	10	50	CHC12X70PF12	V600-8203366
12X80	Partiel	10	50	CHC12X80PF12	V600-8203365
12X90	Partiel	10	50	CHC12X90PF12	V600-8203364
12X100	Partiel	10	50	CHC12X100PF12	V600-8203363
14X40	Total	12	100	CHC14X40EF12	V600-8203362
14X60	Partiel	12	50	CHC14X60PF12	V600-8203361
16X40	Total	14	50	CHC16X40EF12	V600-8203360
16X60	Total	14	50	CHC16X60EF12	V600-8203359
16X100	Partiel	14	25	CHC16X100PF12	V600-8203358
16X120	Partiel	14	25	CHC16X120PF12	V600-8203357
20X80	Partiel	17	25	CHC20X80PF12	V600-8203356

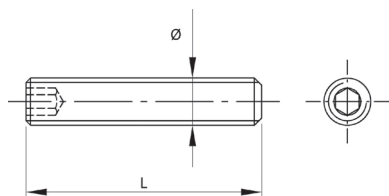

DIN
913

ISO
4026

Dimensions ØxL (mm)	Filetage	Clé	Boi- tage	Code	Référence
2X3	Total	0,9	100	STHCPLA2X3EFBR	V600-8203848
2X4	Total	0,9	100	STHCPLA2X4EFBR	V600-8203847
2X5	Total	0,9	100	STHCPLA2X5EFBR	V600-8203846
2X6	Total	0,9	100	STHCPLA2X6EFBR	V600-8203845
2,5X3	Total	1,3	100	STHCPLA2,5X3EFBR	V600-8203844
2,5X8	Total	1,3	100	STHCPLA2,5X8EFBR	V600-8203843
3X3	Total	1,5	200	STHCPLA3X3EFBR	V600-8203842
3X4	Total	1,5	200	STHCPLA3X4EFBR	V600-8203841
3X5	Total	1,5	200	STHCPLA3X5EFBR	V600-8203840
3X6	Total	0,9	200	STHCPLA3X6EFBR	V600-8205171
3X8	Total	1,5	200	STHCPLA3X8EFBR	V600-8203838
3X10	Total	1,5	200	STHCPLA3X10EFBR	V600-8205172
3X12	Total	1,5	200	STHCPLA3X12EFBR	V600-8203836
3X16	Total	1,5	200	STHCPLA3X16EFBR	V600-8203835
3X20	Total	1,5	200	STHCPLA3X20EFBR	V600-8203834
3X30	Total	1,5	200	STHCPLA3X30EFBR	V600-8203833
4X4	Total	2	200	STHCPLA4X4EFBR	V600-8203832
4X5	Total	2	200	STHCPLA4X5EFBR	V600-8203831
4X6	Total	2	200	STHCPLA4X6EFBR	V600-8203830
4X8	Total	2	200	STHCPLA4X8EFBR	V600-8203829
4X10	Total	2	200	STHCPLA4X10EFBR	V600-8203828
4X12	Total	2	200	STHCPLA4X12EFBR	V600-8203827
4X16	Total	2	200	STHCPLA4X16EFBR	V600-8203826
4X20	Total	2	200	STHCPLA4X20EFBR	V600-8203825
4X25	Total	2	200	STHCPLA4X25EFBR	V600-8203824
4X30	Total	2	200	STHCPLA4X30EFBR	V600-8203823
5X5	Total	2,5	200	STHCPLA5X5EFBR	V600-8203822
5X6	Total	2,5	200	STHCPLA5X6EFBR	V600-8203821
5X8	Total	2,5	200	STHCPLA5X8EFBR	V600-8203820
5X12	Total	2,5	200	STHCPLA5X12EFBR	V600-8203819
5X16	Total	2,5	200	STHCPLA5X16EFBR	V600-8203818
5X20	Total	2,5	200	STHCPLA5X20EFBR	V600-8203817
5X25	Total	2,5	200	STHCPLA5X25EFBR	V600-8203816
5X30	Total	2,5	200	STHCPLA5X30EFBR	V600-8203815
5X40	Total	2,5	100	STHCPLA5X40EFBR	V600-8203814
6X5	Total	3	200	STHCPLA6X5EFBR	V600-8203813
6X6	Total	3	200	STHCPLA6X6EFBR	V600-8203812
6X8	Total	3	200	STHCPLA6X8EFBR	V600-8203811
6X10	Total	3	200	STHCPLA6X10EFBR	V600-8203810
6X12	Total	3	200	STHCPLA6X12EFBR	V600-8203809
6X16	Total	3	200	STHCPLA6X16EFBR	V600-8203808
6X20	Total	3	200	STHCPLA6X20EFBR	V600-8203807
6X25	Total	3	200	STHCPLA6X25EFBR	V600-8203806

Dimensions ØxL (mm)	Filetage	Clé	Boi- tage	Code	Référence
6X30	Total	3	200	STHCPLA6X30EFBR	V600-8203805
6X35	Total	3	200	STHCPLA6X35EFBR	V600-8203804
6X50	Total	3	200	STHCPLA6X50EFBR	V600-8203803
8X6	Total	4	200	STHCPLA8X6EFBR	V600-8203802
8X8	Total	4	200	STHCPLA8X8EFBR	V600-8203801
8X10	Total	4	200	STHCPLA8X10EFBR	V600-8203800
8X12	Total	4	200	STHCPLA8X12EFBR	V600-8203799
8X16	Total	4	200	STHCPLA8X16EFBR	V600-8203798
8X20	Total	4	200	STHCPLA8X20EFBR	V600-8203797
8X25	Total	4	200	STHCPLA8X25EFBR	V600-8203796
8X30	Total	4	200	STHCPLA8X30EFBR	V600-8203795
8X35	Total	4	100	STHCPLA8X35EFBR	V600-8203794
8X40	Total	4	100	STHCPLA8X40EFBR	V600-8203793
8X50	Total	4	100	STHCPLA8X50EFBR	V600-8203792
8X60	Total	4	100	STHCPLA8X60EFBR	V600-8203791
8X80	Total	4	100	STHCPLA8X80EFBR	V600-8203790
10X10	Total	5	50	STHCPLA10X10EFBR	V600-8203789
10X12	Total	5	200	STHCPLA10X12EFBR	V600-8203788
10X16	Total	5	200	STHCPLA10X16EFBR	V600-8203787
10X20	Total	5	200	STHCPLA10X20EFBR	V600-8203786
10X25	Total	5	100	STHCPLA10X25EFBR	V600-8203785
10X30	Total	5	100	STHCPLA10X30EFBR	V600-8203784
10X40	Total	5	100	STHCPLA10X40EFBR	V600-8203783
10X50	Total	5	100	STHCPLA10X50EFBR	V600-8203782
10X60	Total	5	100	STHCPLA10X60EFBR	V600-8203781
12X10	Total	6	100	STHCPLA12X10EFBR	V600-8203780
12X12	Total	6	100	STHCPLA12X12EFBR	V600-8203779
12X16	Total	6	100	STHCPLA12X16EFBR	V600-8203778
12X20	Total	6	100	STHCPLA12X20EFBR	V600-8205173
12X30	Total	6	100	STHCPLA12X30EFBR	V600-8203776
12X35	Total	6	100	STHCPLA12X35EFBR	V600-8203775
12X40	Total	6	100	STHCPLA12X40EFBR	V600-8203774
12X50	Total	6	100	STHCPLA12X50EFBR	V600-8203773
12X60	Total	6	25	STHCPLA12X60EFBR	V600-8203772
12X70	Total	6	100	STHCPLA12X70EFBR	V600-8203771
14X20	Total	6	100	STHCPLA14X20EFBR	V600-8203770
14X30	Total	6	100	STHCPLA14X30EFBR	V600-8203769
16X20	Total	8	50	STHCPLA16X20EFBR	V600-8203768
16X30	Total	8	50	STHCPLA16X30EFBR	V600-8205174
16X40	Total	8	50	STHCPLA16X40EFBR	V600-8203766
16X50	Total	8	50	STHCPLA16X50EFBR	V600-8203765
16X70	Total	8	100	STHCPLA16X70EFBR	V600-8203764

Autres dimensions disponibles sur demande.

VIS STHC - VIS SANS TÊTE HEXAGONALE CREUSE BOUT POINTEAU 12.9



DIN
914

ISO
4027

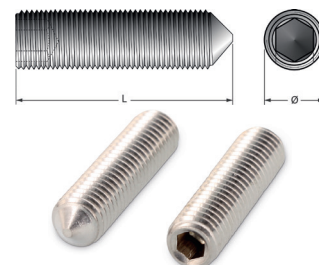

Dimensions ØxL (mm)	Filetage	Clé	Boi- tage	Code	Référence
3X3	Total	1.5	200	STHC3X3BTPNTO12BR	V600-8203521
3X4	Total	1.5	200	STHC3X4BTPNTO12BR	V600-8203520
3X5	Total	1.5	200	STHC3X5BTPNTO12BR	V600-8203519
3X6	Total	1.5	200	STHC3X6BTPNTO12BR	V600-8203518
3X8	Total	1.5	200	STHC3X8BTPNTO12BR	V600-8203517
3X10	Total	1.5	200	STHC3X10BTPNTO12BR	V600-8203516
3X12	Total	1.5	200	STHC3X12BTPNTO12BR	V600-8203515
3X16	Total	1.5	200	STHC3X16BTPNTO12BR	V600-8203514
3X20	Total	1.5	200	STHC3X20BTPNTO12BR	V600-8203513
3X30	Total	1.5	200	STHC3X30BTPNTO12BR	V600-8203512
4X4	Total	2	200	STHC4X4BTPNTO12BR	V600-8203511
4X5	Total	2	200	STHC4X5BTPNTO12BR	V600-8203510
4X6	Total	2	200	STHC4X6BTPNTO12BR	V600-8203509
4X8	Total	2	200	STHC4X8BTPNTO12BR	V600-8203508
4X10	Total	2	200	STHC4X10BTPNTO12BR	V600-8203507
4X12	Total	2	200	STHC4X12BTPNTO12BR	V600-8203506
4X16	Total	2	200	STHC4X16BTPNTO12BR	V600-8203505
4X20	Total	2	200	STHC4X20BTPNTO12BR	V600-8203504
4X30	Total	2	200	STHC4X30BTPNTO12BR	V600-8203503
5X5	Total	2.5	200	STHC5X5BTPNTO12BR	V600-8203502
5X6	Total	2.5	200	STHC5X6BTPNTO12BR	V600-8203501
5X8	Total	2.5	200	STHC5X8BTPNTO12BR	V600-8203500
5X10	Total	2.5	200	STHC5X10BTPNTO12BR	V600-8203499
5X12	Total	2.5	200	STHC5X12BTPNTO12BR	V600-8203498
5X16	Total	2.5	200	STHC5X16BTPNTO12BR	V600-8203497
5X20	Total	2.5	200	STHC5X20BTPNTO12BR	V600-8203496
5X25	Total	2.5	200	STHC5X25BTPNTO12BR	V600-8203495
5X30	Total	2.5	200	STHC5X30BTPNTO12BR	V600-8203494
5X35	Total	2.5	100	STHC5X35BTPNTO12BR	V600-8203493
5X40	Total	2.5	100	STHC5X40BTPNTO12BR	V600-8203492
5X50	Total	2.5	100	STHC5X50BTPNTO12BR	V600-8203491
6X6	Total	3	200	STHC6X6BTPNTO12BR	V600-8203490
6X8	Total	3	200	STHC6X8BTPNTO12BR	V600-8203489
6X10	Total	3	200	STHC6X10BTPNTO12BR	V600-8203488
6X12	Total	3	200	STHC6X12BTPNTO12BR	V600-8203487
6X16	Total	3	200	STHC6X16BTPNTO12BR	V600-8203486
6X20	Total	3	200	STHC6X20BTPNTO12BR	V600-8203485

Dimensions ØxL (mm)	Filetage	Clé	Boi- tage	Code	Référence
6X25	Total	3	200	STHC6X25BTPNTO12BR	V600-8203484
6X30	Total	3	200	STHC6X30BTPNTO12BR	V600-8203483
6X35	Total	3	200	STHC6X35BTPNTO12BR	V600-8203482
6X40	Total	3	100	STHC6X40BTPNTO12BR	V600-8203481
6X50	Total	3	100	STHC6X50BTPNTO12BR	V600-8205175
6X60	Total	3	50	STHC6X60BTPNTO12BR	V600-8203479
8X8	Total	4	200	STHC8X8BTPNTO12BR	V600-8203478
8X10	Total	4	200	STHC8X10BTPNTO12BR	V600-8203477
8X12	Total	4	200	STHC8X12BTPNTO12BR	V600-8203476
8X16	Total	4	200	STHC8X16BTPNTO12BR	V600-8203475
8X20	Total	4	200	STHC8X20BTPNTO12BR	V600-8203474
8X30	Total	4	200	STHC8X30BTPNTO12BR	V600-8203473
8X40	Total	4	100	STHC8X40BTPNTO12BR	V600-8203472
8X50	Total	4	100	STHC8X50BTPNTO12BR	V600-8203471
8X60	Total	4	100	STHC8X60BTPNTO12BR	V600-8203470
10X10	Total	5	200	STHC10X10BTPNTO12BR	V600-8205177
10X16	Total	5	200	STHC10X16BTPNTO12BR	V600-8203468
10X20	Total	5	200	STHC10X20BTPNTO12BR	V600-8203467
10X25	Total	5	100	STHC10X25BTPNTO12BR	V600-8203466
10X30	Total	5	100	STHC10X30BTPNTO12BR	V600-8203465
10X40	Total	5	100	STHC10X40BTPNTO12BR	V600-8203464
10X50	Total	5	100	STHC10X50BTPNTO12BR	V600-8203463
10X60	Total	5	100	STHC10X60BTPNTO12BR	V600-8203462
12X16	Total	6	100	STHC12X16BTPNTO12BR	V600-8203461
12X20	Total	6	100	STHC12X20BTPNTO12BR	V600-8203460
12X25	Total	6	100	STHC12X25BTPNTO12BR	V600-8203459
12X35	Total	6	100	STHC12X35BTPNTO12BR	V600-8203458
12X40	Total	6	100	STHC12X40BTPNTO12BR	V600-8203457
12X50	Total	6	100	STHC12X50BTPNTO12BR	V600-8203456
14X16	Total	6	100	STHC14X16BTPNTO12BR	V600-8203455
14X30	Total	6	100	STHC14X30BTPNTO12BR	V600-8203454
14X70	Total	6	100	STHC14X70BTPNTO12BR	V600-8205176
16X16	Total	8	50	STHC16X16BTPNTO12BR	V600-8203452
16X25	Total	8	50	STHC16X25BTPNTO12BR	V600-8203451
16X40	Total	8	50	STHC16X40BTPNTO12BR	V600-8203450
16X70	Total	8	50	STHC16X70BTPNTO12BR	V600-8205178
16X100	Total	8	100	STHC16X100BTPNTO12BR	V600-8203448

Autres dimensions disponibles sur demande.

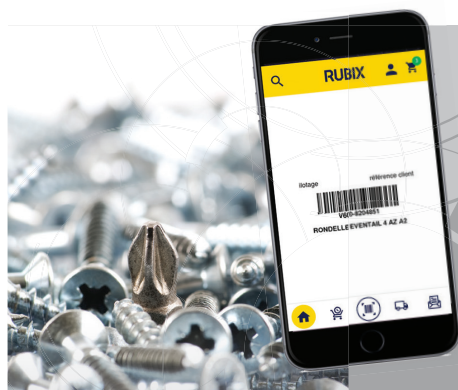

X Scannez et commandez !

Facilitez votre réassort en utilisant notre solution de scan ou notre application mobile Rubix.



DIN 933

ISO 4014

DIN 931

DIN 961

ISO 4017

ISO 8676

Dimensions ØxL (mm)	Filetage	Boîtage	Code	Référence
4x35	Partiel	500	TH4X35PF8BR	V600-8208335
4x40	Partiel	500	TH4X40PF8BR	V600-8208334
5x30	Partiel	200	TH5X30PF8BR	V600-8208333
5x35	Partiel	200	TH5X35PF8BR	V600-8208332
5x50	Partiel	200	TH5X50PF8BR	V600-8208331
5x60	Partiel	200	TH5X60PF8BR	V600-8208330
6x30	Partiel	200	TH6X30PF8BR	V600-8208329
6x35	Partiel	200	TH6X35PF8BR	V600-8208328
6x40	Partiel	200	TH6X40PF8BR	V600-8208327
6x45	Partiel	200	TH6X45PF8BR	V600-8208326
6x50	Partiel	200	TH6X50PF8BR	V600-8208325
6x55	Partiel	200	TH6X55PF8BR	V600-8208324
6x60	Partiel	200	TH6X60PF8BR	V600-8208323
6x70	Partiel	200	TH6X70PF8BR	V600-8208322
6x75	Partiel	200	TH6X75PF8BR	V600-8208321
6x80	Partiel	200	TH6X80PF8BR	V600-8208320
6x100	Partiel	100	TH6X100PF8BR	V600-8208319
6x110	Partiel	100	TH6X110PF8BR	V600-8208318
8x35	Partiel	200	TH8X35PF8BR	V600-8208317
8x40	Partiel	200	TH8X40PF8BR	V600-8208316
8x45	Partiel	200	TH8X45PF8BR	V600-8208315
8x50	Partiel	200	TH8X50PF8BR	V600-8208314
8x60	Partiel	200	TH8X60PF8BR	V600-8208313
8x70	Partiel	200	TH8X70PF8BR	V600-8208312
8x80	Partiel	200	TH8X80PF8BR	V600-8208311
8x90	Partiel	100	TH8X90PF8BR	V600-8208310
8x100	Partiel	100	TH8X100PF8BR	V600-8208309
8x110	Partiel	100	TH8X110PF8BR	V600-8208308
8x120	Partiel	100	TH8X120PF8BR	V600-8208307
8x130	Partiel	100	TH8X130PF8BR	V600-8208306
8x140	Partiel	50	TH8X140PF8BR	V600-8208305
10x40	Partiel	100	TH10X40PF8BR	V600-8208304
10x50	Partiel	100	TH10X50PF8BR	V600-8208303
10x60	Partiel	100	TH10X60PF8BR	V600-8208302
10x70	Partiel	100	TH10X70PF8BR	V600-8208301
10x75	Partiel	100	TH10X75PF8BR	V600-8208300
10x80	Partiel	100	TH10X80PF8BR	V600-8208299
10x90	Partiel	100	TH10X90PF8BR	V600-8208298
10x100	Partiel	100	TH10X100PF8BR	V600-8208297
10x110	Partiel	50	TH10X110PF8BR	V600-8208296
10x120	Partiel	50	TH10X120PF8BR	V600-8208295
10x140	Partiel	50	TH10X140PF8BR	V600-8208294
10x160	Partiel	50	TH10X160PF8BR	V600-8208293
10x180	Partiel	50	TH10X180PF8BR	V600-8208292
10x220	Partiel	50	TH10X220PF8BR	V600-8208291
12x45	Partiel	100	TH12X45PF8BR	V600-8208290
12x50	Partiel	100	TH12X50PF8BR	V600-8208289
12x55	Partiel	100	TH12X55PF8BR	V600-8208288
12x60	Partiel	50	TH12X60PF8BR	V600-8208287
12x65	Partiel	50	TH12X65PF8BR	V600-8208286
12x70	Partiel	50	TH12X70PF8BR	V600-8208285
12x90	Partiel	50	TH12X90PF8BR	V600-8208284
12x100	Partiel	50	TH12X100PF8BR	V600-8208283
12x110	Partiel	50	TH12X110PF8BR	V600-8208282
12x120	Partiel	50	TH12X120PF8BR	V600-8208281

Dimensions ØxL (mm)	Filetage	Boîtage	Code	Référence
12x140	Partiel	50	TH12X140PF8BR	V600-8208280
12x150	Partiel	50	TH12X150PF8BR	V600-8208279
12x180	Partiel	25	TH12X180PF8BR	V600-8208278
14x50	Partiel	50	TH14X50PF8BR	V600-8208277
14x60	Partiel	50	TH14X60PF8BR	V600-8208276
14x65	Partiel	50	TH14X65PF8BR	V600-8208275
14x70	Partiel	50	TH14X70PF8BR	V600-8208274
14x80	Partiel	50	TH14X80PF8BR	V600-8208273
14x90	Partiel	50	TH14X90PF8BR	V600-8208272
14x100	Partiel	50	TH14X100PF8BR	V600-8208271
14x110	Partiel	50	TH14X110PF8BR	V600-8208270
14x120	Partiel	50	TH14X120PF8BR	V600-8208269
16x50	Partiel	100	TH16X50PF8BR	V600-8208268
16x55	Partiel	50	TH16X55PF8BR	V600-8208267
16x60	Partiel	50	TH16X60PF8BR	V600-8208266
16x65	Partiel	25	TH16X65PF8BR	V600-8208265
16x70	Partiel	25	TH16X70PF8BR	V600-8208264
16x80	Partiel	25	TH16X80PF8BR	V600-8208263
16x90	Partiel	25	TH16X90PF8BR	V600-8208262
16x100	Partiel	25	TH16X100PF8BR	V600-8208261
16x110	Partiel	25	TH16X110PF8BR	V600-8208260
16x120	Partiel	25	TH16X120PF8BR	V600-8208259
16x130	Partiel	25	TH16X130PF8BR	V600-8208258
16x140	Partiel	25	TH16X140PF8BR	V600-8208257
16x150	Partiel	25	TH16X150PF8BR	V600-8208256
16x160	Partiel	25	TH16X160PF8BR	V600-8208255
16x180	Partiel	25	TH16X180PF8BR	V600-8208254
16x200	Partiel	25	TH16X200PF8BR	V600-8208253
16x220	Partiel	25	TH16X220PF8BR	V600-8208252
16x250	Partiel	25	TH16X250PF8BR	V600-8208251
18x60	Partiel	25	TH18X60PF8BR	V600-8208250
18x70	Partiel	25	TH18X70PF8BR	V600-8208249
18x90	Partiel	25	TH18X90PF8BR	V600-8208248
18x100	Partiel	25	TH18X100PF8BR	V600-8208247
18x140	Partiel	25	TH18X140PF8BR	V600-8208246
18x200	Partiel	10	TH18X200PF8BR	V600-8208245
20x60	Partiel	50	TH20X60PF8BR	V600-8208244
20x70	Partiel	25	TH20X70PF8BR	V600-8208243
20x80	Partiel	25	TH20X80PF8BR	V600-8208242
20x85	Partiel	25	TH20X85PF8BR	V600-8208241
20x100	Partiel	25	TH20X100PF8BR	V600-8208240
20x110	Partiel	25	TH20X110PF8BR	V600-8208239
20x130	Partiel	25	TH20X130PF8BR	V600-8208238
20x140	Partiel	25	TH20X140PF8BR	V600-8208237
20x180	Partiel	10	TH20X180PF8BR	V600-8208236
20x200	Partiel	10	TH20X200PF8BR	V600-8208235
20x220	Partiel	10	TH20X220PF8BR	V600-8208234
20x240	Partiel	10	TH20X240PF8BR	V600-8208233
22x70	Partiel	25	TH22X70PF8BR	V600-8208232
22x80	Partiel	25	TH22X80PF8BR	V600-8208231
22x90	Partiel	25	TH22X90PF8BR	V600-8208230
22x100	Partiel	10	TH22X100PF8BR	V600-8208229
22x120	Partiel	10	TH22X120PF8BR	V600-8208228
22x140	Partiel	10	TH22X140PF8BR	V600-8208227
24x80	Partiel	25	TH24X80PF8BR	V600-8208226

(Suite) VIS TÊTE HEXAGONALE 8.8

Dimensions ØxL (mm)	Filetage	Boîtage	Code	Référence
24x90	Partiel	10	TH24X90PF8BR	V600-8208225
24x100	Partiel	10	TH24X100PF8BR	V600-8208224
24x110	Partiel	10	TH24X110PF8BR	V600-8208223
24x120	Partiel	10	TH24X120PF8BR	V600-8208222
24x130	Partiel	10	TH24X130PF8BR	V600-8208221
24x140	Partiel	10	TH24X140PF8BR	V600-8208220
24x150	Partiel	10	TH24X150PF8BR	V600-8208219
24x180	Partiel	10	TH24X180PF8BR	V600-8208218
24x220	Partiel	10	TH24X220PF8BR	V600-8208217
24x240	Partiel	10	TH24X240PF8BR	V600-8208216
24x250	Partiel	10	TH24X250PF8BR	V600-8208215
27x80	Partiel	10	TH27X80PF8BR	V600-8208214
27x100	Partiel	10	TH27X100PF8BR	V600-8208213
27x120	Partiel	10	TH27X120PF8BR	V600-8208212
27x130	Partiel	10	TH27X130PF8BR	V600-8208211
27x150	Partiel	10	TH27X150PF8BR	V600-8208210
27x230	Partiel	10	TH27X230PF8BR	V600-8208209
30x80	Partiel	10	TH30X80PF8BR	V600-8208208
30x90	Partiel	10	TH30X90PF8BR	V600-8208207
30x100	Partiel	10	TH30X100PF8BR	V600-8208206
30x110	Partiel	10	TH30X110PF8BR	V600-8208205
30x120	Partiel	10	TH30X120PF8BR	V600-8208204
30x130	Partiel	10	TH30X130PF8BR	V600-8208203
30x160	Partiel	10	TH30X160PF8BR	V600-8208202
30x180	Partiel	5	TH30X180PF8BR	V600-8208201
33x120	Partiel	5	TH33X120PF8BR	V600-8208200
33x180	Partiel	2	TH33X180PF8BR	V600-8208199
33x250	Partiel	2	TH33X250PF8BR	V600-8208198
42x200	Partiel	1	TH42X200PF8BR	V600-8208197
4x8	Total	500	TH4X8EF8BR	V600-8208196
4x10	Total	500	TH4X10EF8BR	V600-8208195
4x12	Total	500	TH4X12EF8BR	V600-8208194
4x16	Total	500	TH4X16EF8BR	V600-8208193
4x20	Total	500	TH4X20EF8BR	V600-8208192
4x25	Total	500	TH4X25EF8BR	V600-8208191
4x30	Total	500	TH4X30EF8BR	V600-8208190
4x35	Total	500	TH4X35EF8BR	V600-8208189
4x40	Total	500	TH4X40EF8BR	V600-8208188
4x50	Total	500	TH4X50EF8BR	V600-8208187
4x60	Total	100	TH4X60EF8BR	V600-8208186
5x8	Total	200	TH5X8EF8BR	V600-8208185
5x10	Total	200	TH5X10EF8BR	V600-8208184
5x12	Total	200	TH5X12EF8BR	V600-8208183
5x16	Total	200	TH5X16EF8BR	V600-8208182
5x20	Total	200	TH5X20EF8BR	V600-8208181
5x25	Total	200	TH5X25EF8BR	V600-8208180
5x30	Total	200	TH5X30EF8BR	V600-8208179
5x35	Total	200	TH5X35EF8BR	V600-8208178
5x40	Total	200	TH5X40EF8BR	V600-8208177
5x45	Total	200	TH5X45EF8BR	V600-8208176
5x50	Total	200	TH5X50EF8BR	V600-8208175
5x60	Total	200	TH5X60EF8BR	V600-8208174
6x8	Total	200	TH6X8EF8BR	V600-8208173
6x10	Total	200	TH6X10EF8BR	V600-8208172
6x12	Total	200	TH6X12EF8BR	V600-8208171
6x14	Total	200	TH6X14EF8BR	V600-8208170
6x16	Total	200	TH6X16EF8BR	V600-8208169
6x20	Total	200	TH6X20EF8BR	V600-8208168
6x22	Total	200	TH6X22EF8BR	V600-8208167
6x25	Total	200	TH6X25EF8BR	V600-8208166
6x30	Total	200	TH6X30EF8BR	V600-8208165
6x35	Total	200	TH6X35EF8BR	V600-8208164
6x40	Total	200	TH6X40EF8BR	V600-8208163

Dimensions ØxL (mm)	Filetage	Boîtage	Code	Référence
6x45	Total	200	TH6/100X45EF8BR	V600-8208162
6x50	Total	200	TH6X50EF8BR	V600-8208161
6x55	Total	200	TH6X55EF8BR	V600-8208160
6x60	Total	200	TH6X60EF8BR	V600-8208159
6x65	Total	200	TH6X65EF8BR	V600-8208158
6x70	Total	200	TH6X70EF8BR	V600-8208157
6x80	Total	200	TH6X80EF8BR	V600-8208156
6x100	Total	100	TH6X100EF8BR	V600-8208155
7x16	Total	200	TH7X16EF8BR	V600-8208154
8x10	Total	200	TH8X10EF8BR	V600-8208153
8x12	Total	200	TH8/125X12EF8BR	V600-8208152
8x16	Total	200	TH8X16EF8BR	V600-8208151
8x20	Total	200	TH8X20EF8BR	V600-8208150
8x30	Total	200	TH8X30EF10BR	V600-8208801
8x35	Total	200	TH8X35EF8BR	V600-8208149
8x40	Total	200	TH8X40EF8BR	V600-8208148
8x45	Total	200	TH8X45EF8BR	V600-8208147
8x50	Total	200	TH8X50EF8BR	V600-8208146
8x55	Total	200	TH8X55EF8BR	V600-8208145
8x60	Total	200	TH8X60EF8BR	V600-8208144
8x65	Total	200	TH8X65EF8BR	V600-8208143
8x70	Total	200	TH8X70EF8BR	V600-8208142
8x80	Total	200	TH8X80EF8BR	V600-8208141
8x90	Total	100	TH8X90EF8BR	V600-8208140
8x100	Total	100	TH8X100EF8BR	V600-8208139
8x110	Total	100	TH8X110EF8BR	V600-8208138
10x16	Total	200	TH10X16EF8BR	V600-8208137
10x20	Total	200	TH10X20EF8BR	V600-8208136
10x25	Total	200	TH10X25EF8BR	V600-8208135
10x30	Total	200	TH10X30EF8BR	V600-8208134
10x35	Total	100	TH10X35EF8BR	V600-8208133
10x40	Total	100	TH10X40EF8BR	V600-8208132
10x45	Total	100	TH10X45EF8BR	V600-8208131
10x50	Total	100	TH10X50EF8BR	V600-8208130
10x55	Total	100	TH10X55EF8BR	V600-8208129
10x70	Total	100	TH10X70EF8BR	V600-8208128
10x80	Total	100	TH10X80EF8BR	V600-8208127
10x90	Total	100	TH10X90EF8BR	V600-8208126
10x100	Total	100	TH10X100EF8BR	V600-8208125
12x20	Total	100	TH12X20EF8BR	V600-8208124
12x25	Total	100	TH12X25EF8BR	V600-8208123
12x30	Total	100	TH12X30EF8BR	V600-8208122
12x35	Total	100	TH12X35EF8BR	V600-8208121
12x40	Total	100	TH12X40EF8BR	V600-8208120
12x45	Total	100	TH12X45EF8BR	V600-8208119
12x50	Total	100	TH12X50EF8BR	V600-8208118
12x55	Total	100	TH12X55EF8BR	V600-8208117
12x60	Total	100	TH12X60EF8BR	V600-8208116
12x70	Total	50	TH12X70EF8BR	V600-8208115
12x80	Total	50	TH12X80EF8BR	V600-8208114
12x90	Total	50	TH12X90EF8BR	V600-8208113
12x100	Total	50	TH12X100EF8BR	V600-8208112
12x120	Total	50	TH12X120EF8BR	V600-8208111
12x140	Total	50	TH12X140EF8BR	V600-8208110
12x150	Total	50	TH12X150EF8BR	V600-8208109
14x20	Total	100	TH14X20EF8BR	V600-8208108
14x25	Total	100	TH14X25EF8BR	V600-8208107
14x30	Total	100	TH14X30EF8BR	V600-8208106
14x35	Total	100	TH14X35EF8BR	V600-8208105
14x40	Total	100	TH14X40EF8BR	V600-8208104
14x45	Total	50	TH14X45EF8BR	V600-8208103
14x55	Total	50	TH14X55EF8BR	V600-8208102
14x60	Total	50	TH14X60EF8BR	V600-8208101

(Suite) VIS TÊTE HEXAGONALE 8.8

Dimensions ØxL (mm)	Filetage	Boîtage	Code	Référence
14x70	Total	50	TH14X70EF8BR	V600-8208100
14x80	Total	50	TH14X80EF8BR	V600-8208099
14x90	Total	50	TH14X90EF8BR	V600-8208098
14x100	Total	50	TH14X100EF8BR	V600-8208097
14x120	Total	50	TH14X120EF8BR	V600-8208096
16x20	Total	50	TH16X20EF8BR	V600-8208095
16x30	Total	50	TH16X30EF8BR	V600-8208094
16x35	Total	50	TH16X35EF8BR	V600-8208093
16x40	Total	50	TH16X40EF8BR	V600-8208092
16x45	Total	50	TH16X45EF8BR	V600-8208091
16x55	Total	50	TH16X55EF8BR	V600-8208089
16x60	Total	50	TH16X60EF8BR	V600-8208088
16x70	Total	25	TH16X70EF8BR	V600-8208087
16x80	Total	25	TH16X80EF8BR	V600-8208086
16x90	Total	25	TH16X90EF8BR	V600-8208085
16x100	Total	25	TH16X100EF8BR	V600-8208084
16x50	Total	50	TH16X50EF8BR	V600-8208090
16x110	Total	25	TH16X110EF8BR	V600-8208083
16x120	Total	25	TH16X120EF8BR	V600-8208082
16x130	Total	25	TH16X130EF8BR	V600-8208081
16x140	Total	25	TH16X140EF8BR	V600-8208080
16x150	Total	25	TH16X150EF8BR	V600-8208079
16x160	Total	25	TH16X160EF8BR	V600-8208078
16x180	Total	25	TH16X180EF8BR	V600-8208077
16x200	Total	25	TH16X200EF8BR	V600-8208076
18x30	Total	50	TH18X30EF8BR	V600-8208075
18x40	Total	50	TH18X40EF8BR	V600-8208074
18x45	Total	50	TH18X45EF8BR	V600-8208073
18x50	Total	50	TH18X50EF8BR	V600-8208072
18x60	Total	25	TH18X60EF8BR	V600-8208071
18x70	Total	25	TH18X70EF8BR	V600-8208070
18x80	Total	25	TH18X80EF8BR	V600-8208069
18x90	Total	25	TH18X90EF8BR	V600-8208068
18x100	Total	25	TH18X100EF8BR	V600-8208067
20x40	Total	25	TH20X40EF8BR	V600-8208065
20x45	Total	25	TH20X45EF8BR	V600-8208064
20x50	Total	25	TH20X50EF8BR	V600-8208063
20x60	Total	25	TH20X60EF8BR	V600-8208062
20x65	Total	25	TH20X65EF8BR	V600-8208061
20x70	Total	25	TH20X70EF8BR	V600-8208060

Dimensions ØxL (mm)	Filetage	Boîtage	Code	Référence
20x30	Total	25	TH20X30EF8BR	V600-8208066
20x80	Total	25	TH20X80EF8BR	V600-8208059
20x90	Total	25	TH20X90EF8BR	V600-8208058
20x100	Total	25	TH20X100EF8BR	V600-8208057
20x110	Total	25	TH20X110EF8BR	V600-8208056
20x120	Total	25	TH20X120EF8BR	V600-8208055
20x130	Total	25	TH20X130EF8BR	V600-8208054
20x140	Total	25	TH20X140EF8BR	V600-8208053
20x150	Total	10	TH20X150EF8BR	V600-8208052
22x40	Total	25	TH22X40EF8BR	V600-8208051
22x50	Total	25	TH22X50EF8BR	V600-8208050
22x70	Total	25	TH22X70EF8BR	V600-8208049
22x80	Total	25	TH22X80EF8BR	V600-8208048
24x40	Total	25	TH24X40EF8BR	V600-8208047
24x45	Total	25	TH24X45EF8BR	V600-8208046
24x50	Total	25	TH24X50EF8BR	V600-8208045
24x60	Total	25	TH24X60EF8BR	V600-8208044
24x70	Total	25	TH24X70EF8BR	V600-8208043
24x80	Total	25	TH24X80EF8BR	V600-8208042
24x90	Total	10	TH24X90EF8BR	V600-8208041
24x100	Total	10	TH24X100EF8BR	V600-8208040
24x110	Total	10	TH24X110EF8BR	V600-8208039
24x120	Total	10	TH24X120EF8BR	V600-8208038
24x140	Total	10	TH24X140EF8BR	V600-8208037
24x150	Total	10	TH24X150EF8BR	V600-8208036
24x160	Total	10	TH24X160EF8BR	V600-8208035
24x180	Total	10	TH24X180EF8BR	V600-8208034
24x200	Total	10	TH24X200EF8BR	V600-8208033
27x80	Total	10	TH27X80EF8BR	V600-8208032
27x90	Total	10	TH27X90EF8BR	V600-8208031
27x100	Total	10	TH27X100EF8BR	V600-8208030
27x120	Total	10	TH27X120EF8BR	V600-8208029
30x60	Total	10	TH30X60EF8BR	V600-8208028
30x70	Total	10	TH30X70EF8BR	V600-8208027
30x80	Total	10	TH30X80EF8BR	V600-8208026
30x90	Total	10	TH30X90EF8BR	V600-8208025
30x120	Total	10	TH30X120EF8BR	V600-8208024
30x140	Total	5	TH30X140EF8BR	V600-8208023
10x1x20	Partiel	200	TH10X120EF8BRDIN961	V600-8208022



VIS À TÊTE HEXAGONALE UNC ASME B18.2.1 ACIER SAE J429 BRUT



Dimensions ØxL (mm)	Filetage	Boîtage	Code	Référence
1/2X1	Total	25	TH1/2X1EFBR	V600-8205215
3/8x1	Total	50	TH3/8X1EFBR	V600-8205216
5/16x1/2	Total	100	TH5/16X1/2EFBR	V600-8205217

VIS À TÊTE CYLINDRIQUE À SIX PANS CREUX



DIN
912

ISO
4762

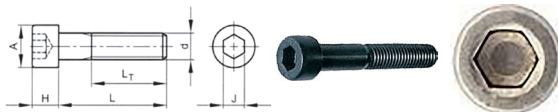

Dimensions ØxL (mm)	Filetage	Boîtage	Code	Référence
1,6x4	Partiel	100	CHC1,6X4PF12	V600-8207862
1,6x6	Total	100	CHC1,6X6EF12	V600-8207861
2x5	Total	100	CHC2X5EF12	V600-8207860
2x6	Total	100	CHC2X6EF12	V600-8207859
2x8	Total	100	CHC2X8EF12	V600-8207858
2x10	Total	100	CHC2X10EF12	V600-8207857
2x12	Total	100	CHC2X12EF12	V600-8207856
2x16	Total	100	CHC2X16EF12	V600-8207855
2x20	Total	100	CHC2X20EF12	V600-8207854
2,5x4	Total	100	CHC2,5X4EF12	V600-8207853
2,5x6	Total	100	CHC2,5X6EF12	V600-8207852
2,5x8	Total	100	CHC2,5X8EF12	V600-8207851
2,5x12	Partiel	100	CHC2,5X12PF12	V600-8207850
2,5x16	Total	100	CHC2,5X16EF12	V600-8207849
2,5x20	Partiel	100	CHC2,5X20PF12	V600-8207848
2,5x25	Total	100	CHC2,5X25EF12	V600-8207847
3x5	Total	100	CHC3X5EF12	V600-8207846
3x6	Total	200	CHC3X6EF12	V600-8207845
3x8	Total	200	CHC3X8EF12	V600-8207844
3x14	Total	200	CHC3X14EF12	V600-8207843
3x45	Partiel	200	CHC3X45PF12	V600-8207842
4x5	Total	200	CHC4X5EF12	V600-8207841
4x6	Total	200	CHC4X6EF12	V600-8207840
4x14	Total	200	CHC4X14EF12	V600-8207839
4x18	Total	200	CHC4X18EF12	V600-8207838
4x22	Total	200	CHC4X22EF12	V600-8207837
4x45	Partiel	200	CHC4X45PF12	V600-8207836
4x55	Partiel	200	CHC4X55PF12	V600-8207835
4x65	Partiel	200	CHC4X65PF12	V600-8207834
4x70	Partiel	200	CHC4X70PF12	V600-8207833
4x75	Partiel	200	CHC4X75PF12	V600-8207832
4x80	Partiel	200	CHC4X80PF12	V600-8207831
4x90	Partiel	200	CHC4X90PF12	V600-8207830
5x6	Total	200	CHC5X6EF12	V600-8207829
5x8	Total	200	CHC5X8EF12	V600-8207828
5x14	Total	200	CHC5X14EF12	V600-8207827
5x18	Total	200	CHC5X18EF12	V600-8207826
5x55	Partiel	200	CHC5X55PF12	V600-8207825
5x65	Partiel	200	CHC5X65PF12	V600-8207824
5x75	Partiel	200	CHC5X75PF12	V600-8207823
5x90	Partiel	200	CHC5X90PF12	V600-8207822
5x100	Partiel	200	CHC5X100PF12	V600-8207821
5x110	Partiel	200	CHC5X110PF12	V600-8207820
5x120	Partiel	100	CHC5X120PF12	V600-8207819
5x130	Partiel	50	CHC5X130PF12	V600-8207818
5x140	Partiel	25	CHC5X140PF12	V600-8207817
5x150	Partiel	25	CHC5X150PF12	V600-8207816
5x160	Partiel	25	CHC5X160PF12	V600-8207815
5x180	Partiel	25	CHC5X180PF12	V600-8207814
5x190	Partiel	25	CHC5X190PF12	V600-8207813
5x200	Partiel	25	CHC5X200PF12	V600-8207812
6x8	Total	200	CHC6X8EF12	V600-8207811
6x14	Total	200	CHC6X14EF12	V600-8207810
6x18	Total	200	CHC6X18EF12	V600-8207809
6x22	Total	200	CHC6X22EF12	V600-8207808
6x55	Partiel	200	CHC6X55PF12	V600-8207807
6x65	Partiel	200	CHC6X65PF12	V600-8207806

Dimensions ØxL (mm)	Filetage	Boîtage	Code	Référence
6x75	Partiel	200	CHC6X75PF12	V600-8207805
6x100	Partiel	100	CHC6X100PF12	V600-8207804
6x110	Partiel	50	CHC6X110PF12	V600-8207803
6x120	Partiel	50	CHC6X120PF12	V600-8207802
6x130	Partiel	50	CHC6X130PF12	V600-8207801
6x140	Partiel	25	CHC6X140PF12	V600-8207800
6x150	Partiel	25	CHC6X150PF12	V600-8207799
6x160	Partiel	25	CHC6X160PF12	V600-8207798
6x180	Partiel	25	CHC6X180PF12	V600-8207797
6x200	Partiel	25	CHC6X200PF12	V600-8207796
8x12	Total	200	CHC8X12EF12	V600-8207795
8x14	Total	200	CHC8X14EF12	V600-8207794
8x18	Total	200	CHC8X18EF12	V600-8207793
8x22	Total	200	CHC8X22EF12	V600-8207792
8x65	Partiel	200	CHC8X65PF12	V600-8207791
8x75	Partiel	200	CHC8X75PF12	V600-8207790
8x85	Partiel	100	CHC8X85PF12	V600-8207789
8x110	Partiel	50	CHC8X110PF12	V600-8207788
8x120	Partiel	50	CHC8X120PF12	V600-8207787
8x130	Partiel	50	CHC8X130PF12	V600-8207786
8x140	Partiel	50	CHC8X140PF12	V600-8207785
8x150	Partiel	50	CHC8X150PF12	V600-8207784
8x160	Partiel	50	CHC8X160PF12	V600-8207783
8x180	Partiel	50	CHC8X180PF12	V600-8207782
10x12	Total	200	CHC10X12EF12	V600-8207780
10x16	Partiel	200	CHC10X16PF12	V600-8207779
10x22	Total	200	CHC10X22EF12	V600-8207778
10x55	Total	100	CHC10X55EF12	V600-8207777
10x65	Partiel	100	CHC10X65PF12	V600-8207776
10x75	Partiel	100	CHC10X75PF12	V600-8207775
10x85	Partiel	100	CHC10X85PF12	V600-8207774
10x110	Partiel	50	CHC10X110PF12	V600-8207773
10x120	Partiel	50	CHC10X120PF12	V600-8207772
10x130	Partiel	50	CHC10X130PF12	V600-8207771
10x140	Partiel	25	CHC10X140PF12	V600-8207770
10x150	Partiel	25	CHC10X150PF12	V600-8207769
10x160	Partiel	25	CHC10X160PF12	V600-8207768
10x170	Partiel	25	CHC10X170PF12	V600-8207767
10x180	Partiel	25	CHC10X180PF12	V600-8207766
10x200	Partiel	25	CHC10X200PF12	V600-8207765
10x220	Partiel	25	CHC10X220PF12	V600-8207764
10x240	Partiel	10	CHC10X240PF12	V600-8207763
12x1	Total	50	CHC12X1,5X30FT12BR	V600-8208800
12x16	Total	100	CHC12X16EF12	V600-8207762
12x20	Total	100	CHC12X20EF12	V600-8207761
12x25	Total	100	CHC12X25EF12	V600-8207760
6x35	Partiel	200	CHC12X35PF12	V600-8203406
12x45	Total	100	CHC12X45EF12	V600-8207759
12x55	Partiel	100	CHC12X55PF12	V600-8207758
12x65	Partiel	50	CHC12X65PF12	V600-8207757
12x75	Partiel	50	CHC12X75PF12	V600-8207756
12x85	Partiel	50	CHC12X85PF12	V600-8207755
12x110	Partiel	50	CHC12X110PF12	V600-8207754
12x120	Partiel	50	CHC12X120PF12	V600-8207753
12x130	Partiel	25	CHC12X130PF12	V600-8207752
12x140	Partiel	25	CHC12X140PF12	V600-8207751
12x150	Total	25	CHC12X150EF12	V600-8207750

(Suite) VIS À TÊTE CYLINDRIQUE À SIX PANS CREUX

Dimensions ØxL (mm)	Filetage	Boitage	Code	Référence
12x160	Partiel	25	CHC12X160PF12	V600-8207749
12x180	Partiel	10	CHC12X180PF12	V600-8207748
12x200	Partiel	10	CHC12X200PF12	V600-8207747
12x220	Partiel	10	CHC12X220PF12	V600-8207746
12x240	Partiel	10	CHC12X240PF12	V600-8207745
12x260	Partiel	10	CHC12X260PF12	V600-8207744
14x20	Total	100	CHC14X20EF12	V600-8207743
14x25	Total	100	CHC14X25EF12	V600-8207742
14x30	Total	100	CHC14X30EF12	V600-8207741
14x35	Total	100	CHC14X35EF12	V600-8207740
14x45	Total	50	CHC14X45EF12	V600-8207739
14x50	Total	50	CHC14X50EF12	V600-8207738
14x55	Total	50	CHC14X55EF12	V600-8207737
14x65	Partiel	50	CHC14X65PF12	V600-8207736
14x70	Partiel	50	CHC14X70PF12	V600-8207735
14x80	Partiel	50	CHC14X80PF12	V600-8207734
14x90	Partiel	50	CHC14X90PF12	V600-8207733
14x100	Partiel	50	CHC14X100PF12	V600-8207732
14x110	Partiel	25	CHC14X110PF12	V600-8207731
14x120	Partiel	25	CHC14X120PF12	V600-8207730
14x130	Partiel	25	CHC14X130PF12	V600-8207729
14x140	Partiel	25	CHC14X140PF12	V600-8207728
14x150	Partiel	25	CHC14X150PF12	V600-8207727
14x160	Partiel	25	CHC14X160PF12	V600-8207726
14x180	Partiel	10	CHC14X180PF12	V600-8207725
14x200	Partiel	10	CHC14X200PF12	V600-8207724
14x220	Partiel	10	CHC14X220PF12	V600-8207723
14x300	Partiel	10	CHC14X300PF12	V600-8207722
16x20	Total	10	CHC16X20EF12	V600-8207721
16x25	Total	50	CHC16X25EF12	V600-8207720
16x30	Total	50	CHC16X30EF12	V600-8207719
16x35	Total	50	CHC16X35EF12	V600-8207718
16x45	Total	50	CHC16X45EF12	V600-8207717
16x50	Total	50	CHC16X50EF12	V600-8207716
16x55	Total	50	CHC16X55EF12	V600-8207715
16x65	Total	25	CHC16X65EF12	V600-8207714
16x70	Total	25	CHC16X70EF12	V600-8207713
16x75	Total	25	CHC16X75EF12	V600-8207712
16x80	Total	25	CHC16X80EF12	V600-8207711
16x90	Total	25	CHC16X90EF12	V600-8207710
16x110	Total	25	CHC16X110EF12	V600-8207709
16x130	Total	25	CHC16X130EF12	V600-8207708
16x140	Total	25	CHC16X140EF12	V600-8207707
16x150	Total	10	CHC16X150EF12	V600-8207706
16x160	Total	10	CHC16X160EF12	V600-8207705
16x190	Total	25	CHC16X190EF12	V600-8207703
16x200	Total	10	CHC16X200EF12	V600-8207702
16x220	Total	10	CHC16X220EF12	V600-8207701
16x240	Total	5	CHC16X240EF12	V600-8207700
16x260	Total	5	CHC16X260EF12	V600-8207699
16x300	Total	5	CHC16X300EF12	V600-8207698
18x30	Total	50	CHC18X30EF12	V600-8207697
18x40	Total	50	CHC18X40EF12	V600-8207696
18x45	Total	50	CHC18X45EF12	V600-8207695
18x50	Total	50	CHC18X50EF12	V600-8207694
18x60	Total	25	CHC18X60EF12	V600-8207693
18x90	Partiel	25	CHC18X90PF12	V600-8207692
18x100	Partiel	25	CHC18X100PF12	V600-8207691
18x120	Partiel	25	CHC18X120PF12	V600-8207690
18x140	Partiel	25	CHC18X140PF12	V600-8207689
18x160	Partiel	10	CHC18X160PF12	V600-8207688
18x180	Partiel	10	CHC18X180PF12	V600-8207687
18x220	Partiel	10	CHC18X220PF12	V600-8207686

Dimensions ØxL (mm)	Filetage	Boitage	Code	Référence
20x30	Total	25	CHC20X30EF12	V600-8207685
20x35	Total	25	CHC20X35EF12	V600-8207684
20x40	Total	25	CHC20X40EF12	V600-8207683
20x45	Total	25	CHC20X45EF12	V600-8207682
20x50	Total	25	CHC20X50EF12	V600-8207681
20x55	Total	25	CHC20X55EF12	V600-8207680
20x60	Total	25	CHC20X60EF12	V600-8207679
20x65	Total	25	CHC20X65EF12	V600-8207678
20x70	Total	25	CHC20X70EF12	V600-8207677
20x75	Partiel	25	CHC20X75PF12	V600-8207676
20x90	Partiel	25	CHC20X90PF12	V600-8207675
20x100	Partiel	25	CHC20X100PF12	V600-8207674
20x110	Partiel	25	CHC20X110PF12	V600-8207673
20x120	Partiel	25	CHC20X120PF12	V600-8207672
20x130	Partiel	25	CHC20X130PF12	V600-8207671
20x140	Partiel	25	CHC20X140PF12	V600-8207670
20x150	Partiel	10	CHC20X150PF12	V600-8207669
20x160	Partiel	10	CHC20X160PF12	V600-8207668
20x180	Partiel	10	CHC20X180PF12	V600-8207667
20x200	Partiel	10	CHC20X200PF12	V600-8207666
20x220	Partiel	10	CHC20X220PF12	V600-8207665
20x240	Partiel	5	CHC20X240PF12	V600-8207664
20x260	Partiel	5	CHC20X260PF12	V600-8207663
22x50	Total	10	CHC22X50EF12	V600-8207662
22x60	Total	10	CHC22X60EF12	V600-8207661
22x70	Total	10	CHC22X70EF12	V600-8207660
22x80	Partiel	10	CHC22X80PF12	V600-8207659
22x90	Partiel	10	CHC22X90PF12	V600-8207658
22x110	Partiel	10	CHC22X110PF12	V600-8207657
22x150	Partiel	10	CHC22X150PF12	V600-8207656
22x180	Partiel	10	CHC22X180PF12	V600-8207655
22x200	Partiel	10	CHC22X200PF12	V600-8207654
24x40	Total	10	CHC24X40EF12	V600-8207653
24x50	Total	10	CHC24X50EF12	V600-8207652
24x60	Total	10	CHC24X60EF12	V600-8207651
24x65	Total	10	CHC24X65EF12	V600-8207650
24x70	Total	10	CHC24X70EF12	V600-8207649
24x80	Total	10	CHC24X80EF12	V600-8207648
24x90	Partiel	10	CHC24X90PF12	V600-8207647
24x100	Partiel	10	CHC24X100PF12	V600-8207646
24x110	Partiel	10	CHC24X110PF12	V600-8207645
24x120	Partiel	5	CHC24X120PF12	V600-8207644
24x130	Partiel	5	CHC24X130PF12	V600-8207643
24x140	Partiel	5	CHC24X140PF12	V600-8207642
24x150	Partiel	5	CHC24X150PF12	V600-8207641
24x160	Partiel	5	CHC24X160PF12	V600-8207640
24x170	Partiel	5	CHC24X170PF12	V600-8207639
24x180	Partiel	5	CHC24X180PF12	V600-8207638
24x200	Partiel	5	CHC24X200PF12	V600-8207637
24x220	Partiel	2	CHC24X220PF12	V600-8207636
24x240	Partiel	2	CHC24X240PF12	V600-8207635
24x260	Partiel	2	CHC24X260PF12	V600-8207634
24x280	Partiel	2	CHC24X280PF12	V600-8207633
24x300	Partiel	2	CHC24X300PF12	V600-8207632
27x50	Total	2	CHC27X50EF12	V600-8207631
27x60	Total	2	CHC27X60EF12	V600-8207630
27x80	Partiel	2	CHC27X80PF12	V600-8207629
27x140	Partiel	2	CHC27X140PF12	V600-8207627
27x180	Partiel	2	CHC27X180PF12	V600-8207626
27x220	Partiel	2	CHC27X220PF12	V600-8207625
27x260	Partiel	2	CHC27X260PF12	V600-8207624
30x50	Total	10	CHC30X50EF12	V600-8207623
30x60	Total	2	CHC30X60EF12	V600-8207622

Suite 

(Suite) VIS À TÊTE CYLINDRIQUE À SIX PANS CREUX

Dimensions ØxL (mm)	Filetage	Boîtage	Code	Référence
27x70	Total	2	CHC27X70EF12	V600-8207629
30x80	Total	2	CHC30X80EF12	V600-8207620
30x90	Total	2	CHC30X90EF12	V600-8207619
30x100	Partiel	2	CHC30X100PF12	V600-8207618
30x110	Partiel	2	CHC30X110PF12	V600-8207617
30x120	Partiel	2	CHC30X120PF12	V600-8207616
30x130	Partiel	2	CHC30X130PF12	V600-8207615
30x140	Partiel	2	CHC30X140PF12	V600-8207614
30x70	Total	2	CHC30X70EF12	V600-8207621
30x170	Partiel	2	CHC30X350PF12	V600-8207612
30x180	Partiel	2	CHC30X180PF12	V600-8207611
30x200	Partiel	2	CHC30X200PF12	V600-8207610
30x220	Partiel	2	CHC30X220PF12	V600-8207609
30x280	Partiel	2	CHC30X280PF12	V600-8207608
30x300	Partiel	2	CHC30X300PF12	V600-8207607
33x90	Total	2	CHC33X90EF12	V600-8207606
33x110	Partiel	5	CHC33X110PF12	V600-8207605
30x160	Partiel	2	CHC30X160PF12	V600-8207613
33x160	Partiel	2	CHC33X160PF12	V600-8207603
33x180	Partiel	2	CHC33X180PF12	V600-8207602
36x90	Total	1	CHC36X90EF12	V600-8207601
36x130	Partiel	5	CHC36X130PF12	V600-8207600
36x180	Partiel	5	CHC36X180PF12	V600-8207599
3x4	Total	200	CHC3X4EF8BR	V600-8207593
3x10	Total	200	CHC3X10EF8BR	V600-8207588
3x30	Total	500	CHC3X30EF8BR	V600-8207586
33x120	Partiel	2	CHC33X120PF12	V600-8207604
4x10	Partiel	200	CHC4X10PF8BR	V600-8207581
4x12	Partiel	200	CHC4X12PF8BR	V600-8207580
4x18	Partiel	200	CHC4X18PF8BR	V600-8207577
4x20	Partiel	200	CHC4X20PF8BR	V600-8207576
4x30	Total	200	CHC4X30EF8BR	V600-8207574
4x8	Partiel	200	CHC4X8PF8BR	V600-8207582
5x30	Total	200	CHC5X30EF8BR	V600-8207558
5x40	Total	200	CHC5X40EF8BR	V600-8208797
5x50	Total	200	CHC5X50EF8BR	V600-8208796
5x60	Total	200	CHC5X60EF8BR	V600-8208795
6x6	Total	500	CHC6X6EF8BR	V600-8207550
6x10	Total	200	CHC6X10EF8BR	V600-8207548
4x50	Total	200	CHC4X50EF8BR	V600-8207572
6x20	Partiel	200	CHC6X20PF8BR	V600-8207543
6x25	Partiel	200	CHC6X25PF8BR	V600-8207542

Dimensions ØxL (mm)	Filetage	Boîtage	Code	Référence
6x30	Partiel	200	CHC6X30PF8BR	V600-8207541
6x50	Total	200	CHC6X50EF8BR	V600-8208794
6x18	Partiel	200	CHC6X18PF8BR	V600-8207544
8x8	Total	200	CHC8X8EF8BR	V600-8207529
8x120	Total	200	CHC8/125X20EF8BR	V600-8207528
8x130	Total	200	CHC8/125X30EF8BR	V600-8207526
8x40	Total	200	CHC8X40EF8BR	V600-8208786
8x45	Total	200	CHC8X45EF8BR	V600-8208785
6x60	Total	200	CHC6X60PF8BR	V600-8208792
10x10	Total	200	CHC10X10EF8BR	V600-8207513
10x50	Total	100	CHC10X50EF8BR	V600-8207506
10x55	Partiel	100	CHC10X55PF8BR	V600-8207505
12x50	Partiel	100	CHC12X50EF8BR	V600-8207485
12x150	Partiel	25	CHC12X150PF8BR	V600-8207475
8x50	Total	200	CHC8X50EF8BR	V600-8208784
16x30	Partiel	50	CHC16X30PF8BRDIN6912	V600-8207597
16x35	Partiel	50	CHC16X35PF8BRDIN6912	V600-8207596
16x65	Partiel	50	CHC16X65PF8BR	V600-8206198
16x70	Partiel	25	CHC16X70PF8BR	V600-8206197
16x80	Partiel	25	CHC16X80PF8BR	V600-8206196
16x90	Partiel	25	CHC16X90PF8BR	V600-8206195
12x170	Partiel	25	CHC12X170PF8BR	V600-8207473
16x130	Partiel	25	CHC16X130PF8BR	V600-8206192
16x140	Partiel	25	CHC16X140PF8BR	V600-8206191
16x150	Partiel	25	CHC16X150PF8BR	V600-8206190
16x160	Partiel	25	CHC16X160PF8BR	V600-8206189
16x170	Partiel	25	CHC16X170PF8BR	V600-8206188
16x180	Partiel	10	CHC16X180PF8BR	V600-8206187
16x200	Partiel	10	CHC16X200PF8BR	V600-8206186
16x220	Partiel	10	CHC16X220PF8BR	V600-8206185
16x110	Partiel	50	CHC16X110PF8BRDIN6912	V600-8207595
18x35	Total	25	CHC18X35EF8BR	V600-8206182
18x70	Partiel	25	CHC18X70PF8BR	V600-8206178
18x80	Partiel	25	CHC18X80PF8BR	V600-8206177
18x110	Partiel	25	CHC18X110PF8BR	V600-8206174
18x150	Partiel	25	CHC18X150PF8BR	V600-8206172
20x55	Partiel	25	CHC20X55PF8BR	V600-8206166
20x60	Partiel	25	CHC20X60PF8BRDIN6912	V600-8207594
22x40	Total	25	CHC22X40EF8BR	V600-8206151
24x80	Partiel	10	CHC24X80PF8BR	V600-8206148
16x300	Partiel	10	CHC16X300PF8BR	V600-8206184

VIS À TÊTE CYLINDRIQUE RÉDUITE À SIX PANS CREUX



Dimensions ØxL (mm)	Filetage	Boîtage	Code	Référence
8x20	Total	200	CHCRED8X20EF8BR	V600-8208777



VIS À METAUX À TÊTE CYLINDRIQUE BOMBÉE PLATE À SIX PANS CREUX



Dimensions ØxL (mm)	Filetage	Boîtage	Code	Référence
4x8	Total	200	VTCBP4X8EF10BR	V600-8208776
5x10	Total	200	VTCBP5X10EF10BR	V600-8208775
6x10	Total	200	VTCBP6X10EF10BR	V600-8208774



Dimensions ØxL (mm)	Filetage	Boîtage	Code	Référence
6x12	Total	200	VTCBP6X12EF10BR	V600-8208773
8x20	Total	200	VTCBP8X20EF10BR	V600-8208772



DIN
7991

ISO
10642

Dimensions ØxL (mm)	Filetage	Boîtage	Code	Référence
3x5	Total	200	FHC3X5EF10BR	V600-8206136
3x6	Total	200	FHC3X6EF10BR	V600-8206135
3x8	Total	200	FHC3X8EF10BR	V600-8206134
3x10	Total	200	FHC3X10EF10BR	V600-8206133
3x12	Total	200	FHC3X12EF10BR	V600-8206132
3x16	Partiel	200	FHC3X16PF10BR	V600-8206131
3x20	Total	200	FHC3X20EF10BR	V600-8206130
3x25	Partiel	200	FHC3X25PF10BR	V600-8206129
3x30	Partiel	200	FHC3X30PF10BR	V600-8206128
3x40	Total	200	FHC3X40EF10BR	V600-8206127
4x6	Total	200	FHC4X6EF10BR	V600-8206126
4x8	Partiel	200	FHC4X8PF10BR	V600-8206125
4x10	Total	200	FHC4X10EF10BR	V600-8206124
4x12	Total	200	FHC4X12EF10BR	V600-8206123
4x14	Total	200	FHC4X14EF10BR	V600-8206122
4x16	Total	200	FHC4X16EF10BR	V600-8206121
4x20	Total	200	FHC4X20EF10BR	V600-8206120
4x25	Total	200	FHC4X25EF10BR	V600-8206119
4x30	Partiel	200	FHC4X30PF10BR	V600-8206118
4x35	Partiel	200	FHC4X35PF10BR	V600-8206117
4x40	Partiel	200	FHC4X40PF10BR	V600-8206116
4x50	Partiel	200	FHC4X50PF10BR	V600-8206115
4x60	Partiel	200	FHC4X60PF10BR	V600-8206114
4x70	Partiel	200	FHC4X70PF10BR	V600-8206113
5x8	Total	200	FHC5X8EF10BR	V600-8206112
5x10	Total	200	FHC5X10EF10BR	V600-8206111
5x12	Total	200	FHC5X12EF10BR	V600-8206110
5x16	Total	200	FHC5X16EF10BR	V600-8206109
5x18	Total	200	FHC5X18EF10BR	V600-8206108
5x20	Total	200	FHC5X20EF10BR	V600-8206107
5x25	Total	200	FHC5X25EF10BR	V600-8206106
5x30	Total	200	FHC5X30EF10BR	V600-8206105
5x35	Partiel	200	FHC5X35PF10BR	V600-8206104
5x40	Partiel	200	FHC5X40PF10BR	V600-8206103
5x45	Partiel	200	FHC5X45PF10BR	V600-8206102
5x50	Partiel	200	FHC5X50PF10BR	V600-8206101
5x60	Partiel	200	FHC5X60PF10BR	V600-8206100
5x70	Total	200	FHC5X70EF10BR	V600-8206099
6x8	Total	200	FHC6X8EF10BR	V600-8206098
6x10	Total	200	FHC6X10EF10BR	V600-8206097
6x12	Total	200	FHC6X12EF10BR	V600-8206096
6x14	Total	200	FHC6X14EF10BR	V600-8206095
6x16	Total	200	FHC6X16EF10BR	V600-8206094
6x18	Total	200	FHC6X18EF10BR	V600-8206093
6x20	Total	200	FHC6X20EF10BR	V600-8206092
6x25	Total	200	FHC6X25EF10BR	V600-8206091
6x30	Total	200	FHC6X30EF10BR	V600-8206090
6x35	Total	200	FHC6X35EF10BR	V600-8206089
6x40	Partiel	200	FHC6X40PF10BR	V600-8206088
6x45	Partiel	200	FHC6X45PF10BR	V600-8206087
6x50	Partiel	200	FHC6X50PF10BR	V600-8206086
6x55	Partiel	200	FHC6X55PF10BR	V600-8206085
6x60	Partiel	200	FHC6X60PF10BR	V600-8206084
6x70	Partiel	200	FHC6X70PF10BR	V600-8206083
6x80	Partiel	200	FHC6X80PF10BR	V600-8206082
6x90	Partiel	200	FHC6X90PF10BR	V600-8206081
6x100	Total	200	FHC6X100EF10BR	V600-8206080
8x10	Total	200	FHC8X10EF10BR	V600-8206079

Dimensions ØxL (mm)	Filetage	Boîtage	Code	Référence
8x12	Total	200	FHC8X12EF10BR	V600-8206078
8x14	Total	200	FHC8X14EF10BR	V600-8206077
8x16	Total	200	FHC8X16EF10BR	V600-8206076
8x20	Total	200	FHC8X20EF10BR	V600-8206075
8x25	Total	200	FHC8X25EF10BR	V600-8206074
8x30	Total	200	FHC8X30EF10BR	V600-8206073
8x35	Total	200	FHC8X35EF10BR	V600-8206072
8x40	Total	200	FHC8X40EF10BR	V600-8206071
8x45	Total	200	FHC8X45EF10BR	V600-8206070
8x50	Partiel	200	FHC8X50PF10BR	V600-8206069
8x55	Partiel	200	FHC8X55PF10BR	V600-8206068
8x60	Partiel	100	FHC8X60PF10BR	V600-8206067
8x70	Partiel	100	FHC8X70PF10BR	V600-8206066
8x80	Partiel	100	FHC8X80PF10BR	V600-8206065
8x90	Partiel	100	FHC8X90PF10BR	V600-8206064
8x100	Partiel	100	FHC8X100PF10BR	V600-8206063
8x140	Partiel	100	FHC8X140PF10BR	V600-8206062
10x12	Total	200	FHC10X12EF10BRISO	V600-8206061
10x16	Total	200	FHC10X16EF10BR	V600-8206060
10x20	Total	200	FHC10X20EF10BR	V600-8206059
10x25	Total	200	FHC10X25EF10BR	V600-8206058
10x30	Total	200	FHC10X30EF10BR	V600-8206057
10x35	Total	100	FHC10X35EF10BR	V600-8206056
10x40	Total	100	FHC10X40EF10BR	V600-8206055
10x45	Total	100	FHC10X45EF10BR	V600-8206054
10x50	Partiel	100	FHC10X50PF10BR	V600-8206053
10x60	Partiel	100	FHC10X60PF10BR	V600-8206052
10x65	Total	100	FHC10X65EF10BR	V600-8206051
10x70	Partiel	100	FHC10X70PF10BR	V600-8206050
10x80	Partiel	100	FHC10X80PF10BR	V600-8206049
10x90	Partiel	100	FHC10X90PF10BR	V600-8206048
10x100	Partiel	50	FHC10X100PF10BR	V600-8206047
10x110	Partiel	100	FHC10X110PF10BR	V600-8206046
10x120	Partiel	50	FHC10X120PF10BR	V600-8206045
12x20	Total	100	FHC12X20EF10BR	V600-8206044
12x25	Total	100	FHC12X25EF10BR	V600-8206043
12x30	Total	100	FHC12X30EF10BR	V600-8206042
12x35	Total	100	FHC12X35EF10BR	V600-8206041
12x40	Total	100	FHC12X40EF10BR	V600-8206040
12x45	Total	100	FHC12X45EF10BR	V600-8206039
12x50	Total	100	FHC12X50EF10BR	V600-8206038
12x60	Partiel	100	FHC12X60PF10BR	V600-8206037
12x70	Partiel	100	FHC12X70PF10BR	V600-8206036
12x80	Partiel	100	FHC12X80PF10BR	V600-8206035
12x90	Partiel	50	FHC12X90PF10BR	V600-8206034
12x100	Partiel	50	FHC12X100PF10BR	V600-8206033
12x110	Partiel	50	FHC12X110PF10BR	V600-8206032
12x120	Partiel	50	FHC12X120PF10BR	V600-8206031
12x130	Total	50	FHC12X130EF10BRISO	V600-8206030
14x25	Total	25	FHC14X25EF10BR	V600-8206029
14x30	Total	25	FHC14X30EF10BR	V600-8206028
14x35	Total	25	FHC14X35EF10BR	V600-8206027
14x40	Total	25	FHC14X40EF10BR	V600-8206026
14x45	Total	50	FHC14X45EF10BR	V600-8206025
14x50	Total	25	FHC14X50EF10BR	V600-8206024
14x55	Total	50	FHC14X55EF10BR	V600-8206023
14x60	Partiel	25	FHC14X60PF10BR	V600-8206022
14x70	Partiel	25	FHC14X70PF10BR	V600-8206021

(Suite) VIS À TÊTE FRAISÉE À SIX PANS CREUX

Dimensions ØxL (mm)	Filetage	Boîtage	Code	Référence
14x80	Partiel	25	FHC14X80PF10BR	V600-8206020
14x100	Partiel	25	FHC14X100PF10BR	V600-8206019
16x30	Total	50	FHC16X30EF10BR	V600-8206018
16x35	Total	50	FHC16X35EF10BR	V600-8206017
16x40	Total	50	FHC16X40EF10BR	V600-8206016
16x45	Total	50	FHC16X45EF10BR	V600-8206015
16x50	Total	50	FHC16X50EF10BR	V600-8206014
16x60	Total	50	FHC16X60EF10BR	V600-8206013
16x70	Partiel	25	FHC16X70PF10BR	V600-8206012
16x90	Partiel	25	FHC16X90PF10BR	V600-8206011
16x100	Total	25	FHC16X100EF10BR	V600-8206010
16x110	Partiel	25	FHC16X110PF10BR	V600-8206009
16x120	Partiel	25	FHC16X120PF10BR	V600-8206008
16x130	Partiel	25	FHC16X130PF10BR	V600-8206007
16x140	Partiel	25	FHC16X140PF10BR	V600-8206006
18x60	Total	25	FHC18X60EF10BR	V600-8206005
18x70	Partiel	25	FHC18X70PF10BR	V600-8206004
16x80	Partiel	25	FHC16X80P10BR	V600-8206003

Dimensions ØxL (mm)	Filetage	Boîtage	Code	Référence
18x90	Partiel	25	FHC18X90PF10BR	V600-8206002
20x40	Total	10	FHC120X40EF10BR	V600-8206001
20x45	Total	25	FHC20X45EF10BR	V600-8206000
20x50	Total	10	FHC20X50EF10BR	V600-8205999
20x60	Total	10	FHC20X60EF10BR	V600-8205998
20x70	Total	10	FHC20X70EF10BR	V600-8205997
20x80	Partiel	10	FHC20X80PF10BR	V600-8205996
20x90	Partiel	10	FHC20X90PF10BR	V600-8205995
20x100	Partiel	10	FHC20X100PF10BR	V600-8205994
20x110	Partiel	10	FHC20X110PF10BR	V600-8205993
20x120	Partiel	10	FHC20X120PF10BR	V600-8205992
24x50	Total	10	FHC24X50EF10BR	V600-8205991
24x60	Total	10	FHC24X60EF10BR	V600-8205990
24x70	Total	10	FHC24X70EF10BR	V600-8205989
24x80	Total	10	FHC24X80EF10BR	V600-8205988
24x90	Total	10	FHC24X90EF10BR	V600-8205987
24x100	Partiel	10	FHC24X100PF10BR	V600-8205986
24x150	Partiel	10	FHC24X150PF10BR	V600-8205985

VIS SANS TÊTE À SIX PANS CREUX



DIN 913

ISO 4026

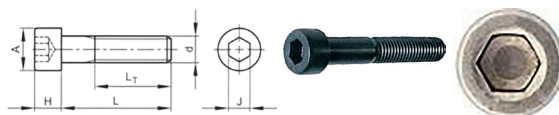

Dimensions ØxL (mm)	Filetage	Boîtage	Code	Référence
2x8	Total	100	STHCPLA2X8EFBR	V600-8205963
2,5x4	Total	100	STHCPLA2,5X4EFBR	V600-8205962
2,5x6	Total	100	STHCPLA2,5X6EFBR	V600-8205961
2,5x10	Total	100	STHCPLA2,5X10EFBR	V600-8205960
4x40	Total	200	STHCPLA4X40EFBR	V600-8205959
5x10	Total	200	STHCPLA5X10EFBR	V600-8205958
5x35	Total	100	STHCPLA5X35EFBR	V600-8205957
6x40	Total	200	STHCPLA6X40EFBR	V600-8205956
6x45	Total	200	STHCPLA6X45EFBR	V600-8205955
6x60	Total	100	STHCPLA6X60EFBR	V600-8205954
8x45	Total	100	STHCPLA8X45EFBR	V600-8205953
8x70	Total	100	STHCPLA8X70EFBR	V600-8205952
10x8	Total	200	STHCPLA10X8EFBR	V600-8205951
10x45	Total	100	STHCPLA10X45EFBR	V600-8205950
10x80	Total	100	STHCPLA10X80EFBR	V600-8205949
10x100	Total	50	STHCPLA10X100EFBR	V600-8205948
12x25	Total	100	STHCPLA12X25EFBR	V600-8205947
12x45	Total	100	STHCPLA12X45EFBR	V600-8205946
12x80	Total	50	STHCPLA12X80EFBR	V600-8205945
12x100	Total	50	STHCPLA12X100EFBR	V600-8205944

Dimensions ØxL (mm)	Filetage	Boîtage	Code	Référence
14x16	Total	50	STHCPLA14X16EFBR	V600-8205943
14x40	Total	50	STHCPLA14X40EFBR	V600-8205942
14x50	Total	50	STHCPLA14X50EFBR	V600-8205941
16x16	Total	50	STHCPLA16X16EFBR	V600-8205940
16x25	Total	50	STHCPLA16X25EFBR	V600-8205939
16x35	Total	50	STHCPLA16X35EFBR	V600-8205938
16x45	Total	50	STHCPLA16X45EFBR	V600-8205937
16x60	Total	25	STHCPLA16X60EFBR	V600-8205936
16x80	Total	25	STHCPLA16X80EFBR	V600-8205935
16x100	Total	25	STHCPLA16X100EFBR	V600-8205934
20x20	Total	10	STHCPLA20X20EFBR	V600-8205933
20x25	Total	10	STHCPLA20X25EFBR	V600-8205932
20x30	Total	50	STHCPLA20X30EFBR	V600-8205931
20x50	Total	50	STHCPLA20X50EFBR	V600-8205930
20x60	Total	25	STHCPLA20X60EFBR	V600-8205929
20x90	Total	25	STHCPLA20X90EFBR	V600-8205928
24x25	Total	50	STHCPLA24X25EFBR	V600-8205927
24x60	Total	25	STHCPLA24X60EFBR	V600-8205926
24x100	Total	25	STHCPLA24X100EFBR	V600-8205925

VIS SANS TÊTE À BOUT CUVETTE



DIN 916



Dimensions ØxL (mm)	Filetage	Boîtage	Code	Référence
5x16	Métrique	200	STHCCUV5X16EFBR	V600-8208762

VIS À TÊTE CYLINDRIQUE À SIX PANS CREUX CL12 UNC ASME B18.3 BRUT

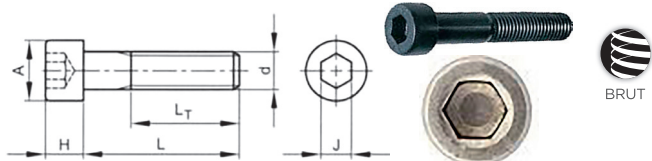

Dimensions ØxL (mm)	Filetage	Boîlage	Code	Référence
1/2X1	Partiel	10	CHC1/2X1PF12	V600-8205234
1/2X64	Partiel	10	CHC1/2X64PF12	V600-8205237
1/2X76	Partiel	10	CHC1/2X76PF12	V600-8205236
1/2X89	Partiel	10	CHC1/2X89PF12	V600-8205235
1/2X1,1/2	Partiel	10	CHC1/2X1,1/2X1PF12	V600-8205232
1/2X1,1/4	Partiel	10	CHC1/2X1,1/4X1PF12	V600-8205233
1/2X2	Partiel	10	CHC1/2X2X1PF12	V600-8205231
1/2X2,1/2	Partiel	10	CHC1/2X2,1/2PF12	V600-8205230
1/2X3	Partiel	10	CHC1/2X3/2X1PF12	V600-8205229
1/4X1/2	Partiel	100	CHC1/4X1/2PF12	V600-8205268
1/4X3/8	Partiel	100	CHC1/4X3/8PF12	V600-8205270
1/4X3/4	Partiel	100	CHC1/4X3/4PF12	V600-8205266
1/4X5/8	Partiel	100	CHC1/4X5/8PF12	V600-8205267
1/4X7/8	Partiel	100	CHC1/4X7/8PF12	V600-8205265
1/4X1	Partiel	100	CHC1/4X1X1PF12	V600-8205264
1/4X1,1/4	Partiel	100	CHC1/4X1,1/4PF12	V600-8205263
1/4X1,1/2	Partiel	100	CHC1/4X1,1/2PF12	V600-8205262
1/4X2	Partiel	50	CHC1/4X2PF12	V600-8205261
1/4X2-1/2	Partiel	100	CHC1/4X2,1/2PF12	V600-8205260
1/4X32	Partiel	100	CHC1/4X32PF12	V600-8205271
1/4X45	Partiel	100	CHC1/4X45PF12	V600-8205269
3/4X2	Partiel	5	CHC3/4X2PF12	V600-8205226
3/4X2,1/4	Partiel	5	CHC3/4X2,1/4PF12	V600-8205225
3/4X3,1/2	Partiel	5	CHC3/4X3,1/2PF12	V600-8205224

Dimensions ØxL (mm)	Filetage	Boîlage	Code	Référence
3/4X4,1/2	Total	5	CHC3/4X4,1/2PF12	V600-8205223
3/8X1	Partiel	50	CHC3/8X1PF12	V600-8205246
3/8X1,1/2	Partiel	25	CHC3/8X1,1/2PF12	V600-8205244
3/8X1,1/4	Partiel	50	CHC3/8X1,1/4PF12	V600-8205245
3/8X1/2	Partiel	50	CHC3/8X1/2PF12	V600-8205249
3/8X1,3/4	Partiel	25	CHC3/8X1,3/4PF12	V600-8205243
3/8X2	Partiel	25	CHC3/8X2PF12	V600-8205242
3/8X2,1/2	Partiel	25	CHC3/8X2,1/2PF12	V600-8205240
3/8X2,1/4	Partiel	25	CHC3/8X2,1/4PF12	V600-8205241
3/8X2,3/4	Partiel	25	CHC3/8X2,3/4PF12	V600-8205239
3/8X3/4	Partiel	50	CHC3/8X3/4PF12	V600-8205248
3/8X7/8	Partiel	50	CHC3/8X7/8PF12	V600-8205247
5/16X38	Partiel	100	CHC5/16X38PF12	V600-8205259
5/16X5/8	Partiel	100	CHC5/16X5/8PF12	V600-8205258
5/16X3/4	Partiel	100	CHC5/16X3/4PF12	V600-8205257
5/16X7/8	Partiel	100	CHC5/16X7/8PF12	V600-8205256
5/16X1	Partiel	50	CHC5/16X1PF12	V600-8205255
5/16X1,1/4	Partiel	50	CHC5/16X1,1/4PF12	V600-8205254
5/16X1,3/4	Partiel	50	CHC5/16X1,3/4PF12	V600-8205253
5/16X2	Partiel	50	CHC5/16X2PF12	V600-8205252
5/16X2,1/4	Partiel	25	CHC5/16X2,1/4PF12	V600-8205251
5/16X2,1/2	Partiel	25	CHC5/16X2,1/2PF12	V600-8205250
5/8X64	Partiel	10	CHC5/8X64PF12	V600-8205228
7/16X3	Partiel	10	CHC7/16X3PF12	V600-8205238

VIS À TÊTE FRAISÉE À SIX PANS CREUX UNC ASME B18.3 BRUT



Dimensions ØxL (mm)	Filetage	Boîlage	Code	Référence
1/4X1	Partiel	100	FHC1/4X1PF10BR	V600-8205221
1/4X3	Partiel	25	FHC1/4X3PF10BR	V600-8205220
1/4X5/8	Partiel	100	FHC1/4X5/8PF10BR	V600-8205222

Dimensions ØxL (mm)	Filetage	Boîlage	Code	Référence
3/8X3/4	Partiel	50	FHC3/8X3/4PF10BR	V600-8205219
3/8X1	Partiel	50	FHC3/8X1PF10BR	V600-8205218

VIS POUR PLAQUE DE PLÂTRE À EMPREINTE PHILLIPS CRUCIFORME



Dimensions ØxL (mm)	Filetage	Boîlage	Code	Référence
3,5x25	Partiel	1000	PLAC3,5X25PHILBRPF	V600-8208749

VIS POUR PLAQUE DE PLÂTRE À EMPREINTE PHILLIPS CRUCIFORME

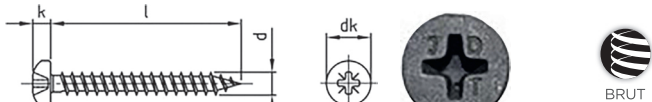

Dimensions ØxL (mm)	Filetage	Boîlage	Code	Référence
3,5X22	Partiel	250	PLAC4,8X70PHILBRPF	V600-8205561

GOUPILLE ÉLASTIQUE SÉRIE ÉPAISSE



DIN
1481

ISO
8752

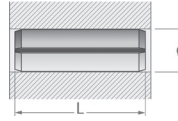

Dimensions ØxL (mm)	Boîtage	Code	Référence
1,5X8	200	GOELAS1,5X8BR	V600-8204122
2X10	200	GOELAS2X10BR	V600-8204121
2X16	200	GOELAS2X16BR	V600-8204120
2X20	200	GOELAS2X20BR	V600-8204119
2,5X12	200	GOELAS2,5X12BR	V600-8204118
2,5X20	200	GOELAS2,5X20BR	V600-8204117
2,5X30	200	GOELAS2,5X30BR	V600-8204116
2,5X40	200	GOELAS2,5X40BR	V600-8204115
3X8	200	GOELAS3X8BR	V600-8204114
3X10	200	GOELAS3X10BR	V600-8204113
3X12	200	GOELAS3X12BR	V600-8204112
3X15	200	GOELAS3X15BR	V600-8204111
3X16	200	GOELAS3X16BR	V600-8204110
3X20	200	GOELAS3X20BR	V600-8204109
3X30	200	GOELAS3X30BR	V600-8204108
3X35	200	GOELAS3X35BR	V600-8204107
3X40	200	GOELAS3X40BR	V600-8204106
4X12	200	GOELAS4X12BR	V600-8204105
4X16	200	GOELAS4X16BR	V600-8204104
4X20	200	GOELAS4X20BR	V600-8204103
4X24	200	GOELAS4X24BR	V600-8204102

Dimensions ØxL (mm)	Boîtage	Code	Référence
4X30	200	GOELAS4X30BR	V600-8204101
4X40	100	GOELAS4X40BR	V600-8204100
4X50	100	GOELAS4X50BR	V600-8204099
4X60	100	GOELAS4X60BR	V600-8204098
5X20	100	GOELAS5X20BR	V600-8204097
5X30	100	GOELAS5X30BR	V600-8204096
5X40	100	GOELAS5X40BR	V600-8204095
5X50	100	GOELAS5X50BR	V600-8204094
5X60	100	GOELAS5X60BR	V600-8204093
6X20	100	GOELAS6X20BR	V600-8204092
6X30	100	GOELAS6X30BR	V600-8204091
6X32	100	GOELAS6X32BR	V600-8204090
6X40	100	GOELAS6X40BR	V600-8204089
6X50	50	GOELAS6X50BR	V600-8204088
6X60	50	GOELAS6X60BR	V600-8204087
8X30	50	GOELAS8X30BR	V600-8204086
8X40	50	GOELAS8X40BR	V600-8204085
8X60	50	GOELAS8X60BR	V600-8204084
8X80	25	GOELAS8X80BR	V600-8204083
10X60	25	GOELAS10X60BR	V600-8204082
10X100	10	GOELAS10X100BR	V600-8204081

Autres dimensions disponibles sur demande.

CIRCLIPS® INTÉRIEUR



DIN
472

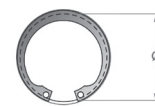

Ø (mm)	Boîtage	Code	Référence
8	250	CIRINT8BR	V600-8205515
10	250	CIRINT10BR	V600-8204204
11	250	CIRINT11BR	V600-8205514
12	250	CIRINT12BR	V600-8204203
13	100	CIRINT13BR	V600-8205513
14	100	CIRINT14BR	V600-8204202
15	100	CIRINT15BR	V600-8205512
16	100	CIRINT16BR	V600-8204201
17	100	CIRINT17BR	V600-8205511
18	100	CIRINT18BR	V600-8204200
19	100	CIRINT19BR	V600-8204199
20	100	CIRINT20BR	V600-8204197
22	100	CIRINT22BR	V600-8205510
24	100	CIRINT24BR	V600-8205509
25	100	CIRINT25BR	V600-8204196
26	100	CIRINT26BR	V600-8205508
28	100	CIRINT28BR	V600-8205507
29	100	CIRINT29BR	V600-8205506
30	100	CIRINT30BR	V600-8204195
31	100	CIRINT31BR	V600-8205505
32	100	CIRINT32BR	V600-8204194
33	100	CIRINT33BR	V600-8205504
35	100	CIRINT35BR	V600-8204198
37	100	CIRINT37BR	V600-8205503
38	100	CIRINT38BR	V600-8205502
39	100	CIRINT39BR	V600-8205501
40	50	CIRINT40BR	V600-8204193
41	50	CIRINT41BR	V600-8205500
42	50	CIRINT42BR	V600-8205499
43	50	CIRINT43BR	V600-8205498
45	50	CIRINT45BR	V600-8204192
47	50	CIRINT47BR	V600-8204191
48	50	CIRINT48BR	V600-8205497
50	50	CIRINT50BR	V600-8205496
52	50	CIRINT52BR	V600-8204190

Ø (mm)	Boîtage	Code	Référence
56	25	CIRINT56BR	V600-8205495
58	25	CIRINT58BR	V600-8205494
60	25	CIRINT60BR	V600-8205493
62	25	CIRINT62BR	V600-8204189
64	25	CIRINT64BR	V600-8205492
65	10	CIRINT65BR	V600-8205491
67	10	CIRINT67BR	V600-8205490
68	10	CIRINT68BR	V600-8205489
70	10	CIRINT70BR	V600-8205488
72	10	CIRINT72BR	V600-8205487
75	10	CIRINT75BR	V600-8205486
77	10	CIRINT77BR	V600-8205485
78	10	CIRINT78BR	V600-8205484
80	10	CIRINT80BR	V600-8205483
85	5	CIRINT85BR	V600-8205482
90	5	CIRINT90BR	V600-8205481
95	5	CIRINT95BR	V600-8205480
98	5	CIRINT98BR	V600-8205479
105	5	CIRINT105BR	V600-8205478
112	5	CIRINT112BR	V600-8205477
125	5	CIRINT125BR	V600-8205476
145	5	CIRINT145BR	V600-8205475
150	3	CIRINT150BR	V600-8205474
160	3	CIRINT160BR	V600-8205473
165	3	CIRINT165BR	V600-8205472
170	3	CIRINT170BR	V600-8205471
175	2	CIRINT175BR	V600-8205470
180	2	CIRINT180BR	V600-8205469
195	2	CIRINT195BR	V600-8205468
215	2	CIRINT215BR	V600-8205467
225	2	CIRINT225BR	V600-8205466
250	2	CIRINT250BR	V600-8205465
260	2	CIRINT260BR	V600-8205464
290	2	CIRINT290BR	V600-8205463

Autres dimensions disponibles sur demande.

CIRCLIPS® : marque déposée

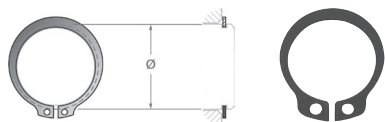

Ø (mm)	Boîtage	Code	Référence	Ø (mm)	Boîtage	Code	Référence
4	500	CIREXT4BR	V600-8204229	42	50	CIREXT42BR	V600-8205544
5	500	CIREXT5BR	V600-8204228	44	50	CIREXT44BR	V600-8205543
6	500	CIREXT6BR	V600-8204227	45	50	CIREXT45BR	V600-8205542
8	250	CIREXT8BR	V600-8204226	47	50	CIREXT47BR	V600-8205541
9	250	CIREXT9BR	V600-8205554	50	50	CIREXT50BR	V600-8204206
10	250	CIREXT10BR	V600-8204225	52	50	CIREXT52BR	V600-8205540
11	250	CIREXT11BR	V600-8205553	55	25	CIREXT55BR	V600-8205539
12	250	CIREXT12BR	V600-8204224	57	25	CIREXT57BR	V600-8205538
14	100	CIREXT14BR	V600-8204223	60	25	CIREXT60BR	V600-8204205
15	100	CIREXT15BR	V600-8204222	62	25	CIREXT62BR	V600-8205537
16	100	CIREXT16BR	V600-8204221	65	10	CIREXT65BR	V600-8205536
17	100	CIREXT17BR	V600-8204219	68	10	CIREXT68BR	V600-8205535
18	100	CIREXT18BR	V600-8204220	70	10	CIREXT70BR	V600-8205534
20	100	CIREXT20BR	V600-8204218	75	10	CIREXT75BR	V600-8205533
21	100	CIREXT21BR	V600-8204217	78	10	CIREXT78BR	V600-8205532
22	100	CIREXT22BR	V600-8204216	80	10	CIREXT80BR	V600-8205531
23	100	CIREXT23BR	V600-8204215	85	5	CIREXT85BR	V600-8205530
24	100	CIREXT24BR	V600-8205551	98	5	CIREXT98BR	V600-8205529
25	100	CIREXT25BR	V600-8204214	100	5	CIREXT100BR	V600-8205528
26	100	CIREXT26BR	V600-8204213	110	5	CIREXT110BR	V600-8205527
28	100	CIREXT28BR	V600-8204212	115	5	CIREXT115BR	V600-8205526
30	100	CIREXT30BR	V600-8204211	125	5	CIREXT125BR	V600-8205525
31	100	CIREXT31BR	V600-8205550	140	5	CIREXT140BR	V600-8205524
32	100	CIREXT32BR	V600-8204210	145	5	CIREXT145BR	V600-8205523
33	100	CIREXT33BR	V600-8205549	150	3	CIREXT150BR	V600-8205522
34	100	CIREXT34BR	V600-8205548	160	3	CIREXT160BR	V600-8205521
35	100	CIREXT35BR	V600-8204209	170	3	CIREXT170BR	V600-8205520
36	100	CIREXT36BR	V600-8204208	180	2	CIREXT180BR	V600-8205519
37	100	CIREXT37BR	V600-8205547	200	2	CIREXT200BR	V600-8205518
38	100	CIREXT38BR	V600-8205546	220	2	CIREXT220BR	V600-8205517
40	50	CIREXT40BR	V600-8204207	240	2	CIREXT240BR	V600-8205516
41	1000	CIREXT41BR	V600-8205545				

Autres dimensions disponibles sur demande.

Réapprovisionnez
votre visserie avec
notre solution scan !



NOUVEAU

- Depuis notre appli mobile Rubix
- Réappro simple et rapide
- Historique des commandes
- Suivi des livraisons



ÉCROU HEXAGONAL 6 PANS

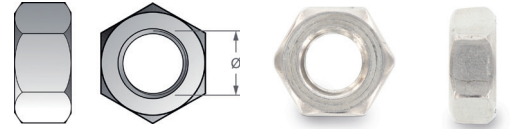

Ø (mm)	Clé	Boîlage	Code	Référence
1,6	3,2	1000	ECHU1,6A2	V600-8208336
2	4	1000	ECHU2A2	V600-8207444
2,5	5	1000	ECHU2,5A2	V600-8207323
3	5,5	500	ECHU3A2	V600-8204886
4	7	500	ECHU4A2	V600-8204885
5	8	500	ECHU5A2	V600-8204884
6	10	500	ECHU6A2	V600-8204883
8	13	200	ECHU8A2	V600-8204882
10	17	100	ECHU10A2	V600-8204881

Ø (mm)	Clé	Boîlage	Code	Référence
12	19	200	ECHU12A2	V600-8204880
14	22	200	ECHU14A2	V600-8204879
16	24	50	ECHU16A2	V600-8204878
18	27	50	ECHU18A2	V600-8204877
20	30	50	ECHU20A2	V600-8204876
22	32	25	ECHU22A2	V600-8204875
24	36	25	ECHU24A2	V600-8204874
30	46	25	ECHU30A2	V600-8204873

Autres dimensions disponibles sur demande.

ÉCROU BAS HEXAGONAL

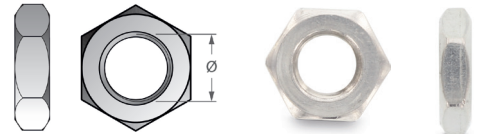

Ø (mm)	Clé	Boîlage	Code	Référence
2	4	1000	ECHUBAS2A2	V600-8207450
3	5,5	500	ECHUBAS3A2	V600-8204922
4	7	500	ECHUBAS4A2	V600-8204923
5	8	500	ECHUBAS5A2	V600-8204920
6	10	500	ECHUBAS6A2	V600-8204919
8	13	500	ECHUBAS8A2	V600-8204918

Ø (mm)	Clé	Boîlage	Code	Référence
10	17	200	ECHUBAS10A2	V600-8204917
12	19	200	ECHUBAS12A2	V600-8204916
14	22	100	ECHUBAS14A2	V600-8204915
16	24	100	ECHUBAS16A2	V600-8204913
18	27	50	ECHUBAS18A2	V600-8204914
20	30	50	ECHUBAS20A2	V600-8204911

Autres dimensions disponibles sur demande.

ÉCROU FREIN BAGUE NYLON

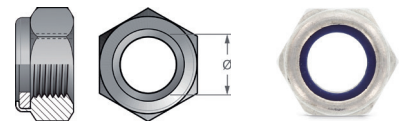

Ø (mm)	Clé	Boîlage	Code	Référence
3	5,5	500	ECFNYL3A2	V600-8204900
4	7	500	ECFNYL4A2	V600-8204899
5	8	500	ECFNYL5A2	V600-8204898
6	10	500	ECFNYL6A2	V600-8204897
8	13	200	ECFNYL8A2	V600-8204896
10	17	200	ECFNYL10A2	V600-8204894

Ø (mm)	Clé	Boîlage	Code	Référence
12	19	100	ECFNYL12A2	V600-8204895
14	22	100	ECFNYL14A2	V600-8204893
16	24	100	ECFNYL16A2	V600-8204892
18	27	50	ECFNYL18A2	V600-8204891
20	30	50	ECFNYL20A2	V600-8204890

Autres dimensions disponibles sur demande.

ÉCROU À OREILLES INOX



Ø (mm)	Boîlage	Code	Référence
4	100	ECOR4A2	V600-8204861
5	100	ECOR5A2	V600-8204860
6	100	ECOR6A2	V600-8204859

Ø (mm)	Boîlage	Code	Référence
8	100	ECOR8A2	V600-8204858
10	100	ECOR10A2	V600-8204857
12	50	ECOR12A2	V600-8204856

Autres dimensions disponibles sur demande.

ÉCROU BORGNE INOX

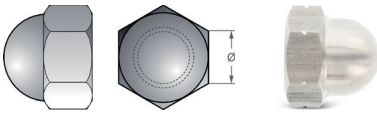

Ø (mm)	Clé	Boîlage	Code	Référence
3	5.5	500	ECHR3MONOA2	V600-8204912
4	7	500	ECHR4MONOA2	V600-8204910
5	8	500	ECHR5MONOA2	V600-8204909
6	10	500	ECHR6MONOA2	V600-8204908
8	13	200	ECHR8MONOA2	V600-8204907
10	17	200	ECHR10MONOA2	V600-8204906

Ø (mm)	Clé	Boîlage	Code	Référence
12	19	100	ECHR12MONOA2	V600-8204905
14	22	50	ECHR14MONOA2	V600-8204904
16	24	50	ECHR16MONOA2	V600-8204903
18	27	25	ECHR18MONOA2	V600-8204902
20	30	25	ECHR20MONOA2	V600-8204901

Autres dimensions disponibles sur demande.

RONDELLE PLATE ÉTROITE A2

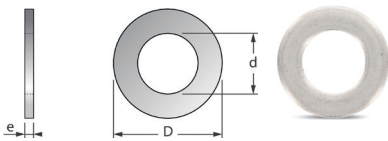

Ø	Dimensions (mm)	Boîlage	Code	Référence
Z3	3,2x6x0,8	500	RONZ3A2	V600-8204828
Z4	4,3x8x0,8	500	RONZ4A2	V600-8204827
Z5	5,3x10x1	200	RONZ5A2	V600-8204826
Z6	6,4x12x1,2	200	RONZ6A2	V600-8204825
Z8	8,4x16x1,5	200	RONZ8A2	V600-8204824
Z10	10,5x20x2	100	RONZ10A2	V600-8204823

Ø	Dimensions (mm)	Boîlage	Code	Référence
Z12	13x24x2,5	100	RONZ12A2	V600-8204822
Z14	15x27x2,5	50	RONZ14A2	V600-8204821
Z16	17x30x3	50	RONZ16A2	V600-8204820
Z18	19x32x3	50	RONZ18A2	V600-8204819
Z20	21x36x3	50	RONZ20A2	V600-8204817

Autres dimensions disponibles sur demande.

RONDELLE PLATE MOYENNE A2

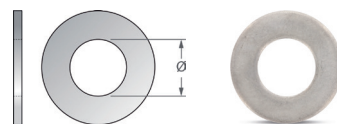

Ø	Dimensions (mm)	Boîtage	Code	Référence
M3	3,2x8x0,8	500	RONMU3A2	V600-8204806
M4	4,3x10x0,8	500	RONMU4A2	V600-8204805
M5	5,3x12x1	200	RONMU5A2	V600-8204804
M6	6,4x14x1,2	200	RONMU6A2	V600-8204803
M7	16x7,4	200	RONMU7A2	V600-8206585
M8	8,4x18x1,5	200	RONMU8A2	V600-8204802
M10	10,5x22x2	100	RONMU10A2	V600-8204801

Ø	Dimensions (mm)	Boîtage	Code	Référence
M12	13x27x2,5	100	RONMU12A2	V600-8204800
M14	15x30x2,5	50	RONMU14A2	V600-8204799
M16	17x32x3	50	RONMU16A2	V600-8204798
M18	19x36x3	50	RONMU18A2	V600-8204797
M20	21x40x3	50	RONMU20A2	V600-8204796
M24	25x50x4	50	RONMU24A2	V600-8204795

Autres dimensions disponibles sur demande.

RONDELLE PLATE LARGE A2



Ø	Dimensions (mm)	Boîtage	Code	Référence
L3	3,2x12x0,8	1000	RONLU3A2	V600-8204818
L4	4,3x14x0,8	500	RONLU4A2	V600-8204815
L5	5,3x16x1	500	RONLU5A2	V600-8204816
L6	6,4x18x1,2	200	RONLU6A2	V600-8204813
L8	8,4x22x1,5	200	RONLU8A2	V600-8204814
L10	10,5x27x2	100	RONLU10A2	V600-8204812

Ø	Dimensions (mm)	Boîtage	Code	Référence
L12	13x32x2,5	100	RONLU12A2	V600-8204811
L14	15x36x2,5	50	RONLU14A2	V600-8204810
L16	17x40x3	50	RONLU16A2	V600-8204809
L18	19x45x3	50	RONLU18A2	V600-8204808
L20	21x50x3	50	RONLU20A2	V600-8204807

RONDELLE PLATE LARGE A2



Ø	Dimensions (mm)	Boîtage	Code	Référence
L3	9x3,2x0,8	1000	RONLU3A2DIN	V600-8207328
L4	4,3x12x1	500	RONLU4A2DIN	V600-8204785
L5	5,3x15x1,2	500	RONLU5A2DIN	V600-8204784
L6	6,4x18x1,8	500	RONLU6A2DIN	V600-8204783
L8	8,4x24x2	500	RONLU8A2DIN	V600-8204781

Ø	Dimensions (mm)	Boîtage	Code	Référence
L10	10,5x30x2,5	500	RONLU10A2DIN	V600-8204782
L12	13x37x3	200	RONLU12A2DIN	V600-8204779
L14	15x44x3	100	RONLU14A2DIN	V600-8204780
L16	17x50x3	100	RONLU16A2DIN	V600-8204777
L18	20x56x4	50	RONLU18A2DIN	V600-8204778

RONDELLE PLATE EXTRA LARGE A2

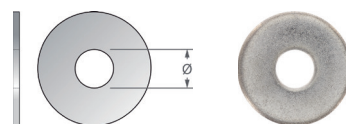

Ø	Dimensions (mm)	Boîtage	Code	Référence
LL3	3,2x14x0,8	500	RONLLU3A2	V600-8204776
LL4	4,3x16x0,8	500	RONLLU4A2	V600-8204774
LL5	5,3x20x1	200	RONLLU5A2	V600-8204773
LL6	6,4x24x1,2	200	RONLLU6A2	V600-8204772
LL8	8,4x30x1,5	200	RONLLU8A2	V600-8204771
LL10	10,5x36x2	100	RONLLU10A2	V600-8204770

Ø	Dimensions (mm)	Boîtage	Code	Référence
LL12	13x40x2,5	100	RONLLU12A2	V600-8204769
LL14	15x45x2,5	50	RONLLU14A2	V600-8204768
LL16	17x50x3	50	RONLLU16A2	V600-8204948
LL18	19x55x3	50	RONLLU19A2	V600-8204957
LL20	21x60x3	25	RONLLU20A2	V600-8204956

Autres dimensions disponibles sur demande.

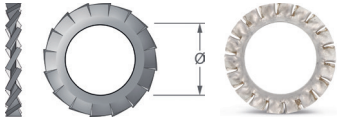

RONDELLE ÉVENTAIL DENTURE EXTÉRIEURE A2



DIN
6798A

Ø	Dimensions (mm)	Boîtage	Code	Référence
AZ2	2,2x4,5	1000	RONAZ2A2	V600-8207321
AZ3	3,4x6x0,4	500	RONAZ3A2	V600-8204850
AZ4	4,5x8x0,5	500	RONAZ4A2	V600-8204851
AZ5	5,5x10x0,6	500	RONAZ5A2	V600-8204849
AZ6	6,6x11x0,7	500	RONAZ6A2	V600-8204848
AZ8	8,6x15x0,8	500	RONAZ8A2	V600-8204847
AZ10	10,8x18x0,9	500	RONAZ10A2	V600-8204846

Ø	Dimensions (mm)	Boîtage	Code	Référence
AZ12	13,3x20,5x1	500	RONAZ12A2	V600-8204845
AZ14	15,3x24x1	500	RONAZ14A2	V600-8204844
AZ16	17,3x26x1,2	500	RONAZ16A2	V600-8204843
AZ18	19,3x30x1,4	200	RONAZ18A2	V600-8204841
AZ20	21,3x33x1,4	200	RONAZ20A2	V600-8204842
A28,0	44x28	100	RONAZ27A2	V600-8207311
A31	48x31	100	RONAZ30A2	V600-8207310

Autres dimensions disponibles sur demande.

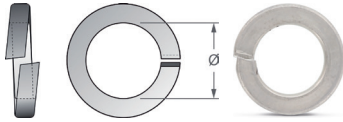

RONDELLE GROWER A2



DIN
127

Ø	Dimensions (mm)	Boîtage	Code	Référence
B2	1x0,9x4,4	1000	RONW2A2	V600-8207459
B2,5	1,4x1x5,1	1000	RONW2,5A2	V600-8207435
W3	3,1x6,2x0,8	500	RONW3A2	V600-8204840
W4	4,1x7,6x0,9	500	RONW4A2	V600-8204839
W5	5,1x9,2x1,2	500	RONW5A2	V600-8204838
W6	6,1x11,8x1,6	500	RONW6A2	V600-8204837
W8	8,1x14,8x2	500	RONW8A2	V600-8204836
W10	10,2x18,1x2,2	500	RONW10A2	V600-8204835
W12	12,2x21,1x2,5	500	RONW12A2	V600-8204834

Ø	Dimensions (mm)	Boîtage	Code	Référence
W14	14,2x24,1x3	500	RONW14A2	V600-8204833
W16	16,2x27,4x3,5	250	RONW16A2	V600-8204832
W18	18,2x29,4x3,5	250	RONW18A2	V600-8204831
W20	20,2x33,6x4	100	RONW20A2	V600-8204830
B22	8x6x35,9	100	RONW22A2	V600-8207437
B24	10x7x40	100	RONW24A2	V600-8207436
B27	10x7x43	100	RONW27A2	V600-8207434
B30	12x8x48,2	50	RONW30A2	V600-8207433

Autres dimensions disponibles sur demande.

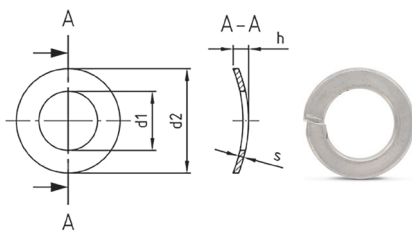

RONDELLE ELASTIQUE FORME A



DIN
127

Ø (mm)	Dimensions (mm)	Boîtage	Code	Référence
A6	1,1x11x6,4	500	RONFLEX6A	V600-8207453



RONDELLE PLATE AFNOR FORME L



NFE
25-514

Ø (mm)	Dimensions (mm)	Boîtage	Code	Référence
L22	55x23	25	RONLU22A2	V600-8206588
L24	60x25	25	RONLU24A2	V600-8206587
L30	70x31	10	RONLU30A2	V600-8206586

RONDELLE PLATE AFNOR FORME Z

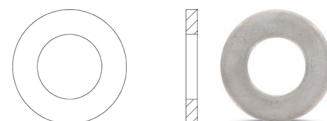

Ø (mm)	Dimensions (mm)	Boîtage	Code	Référence
Z2	4x2,2	500	RONZ2A2	V600-8206584
Z22	40x23	25	RONZ22A2	V600-8206583
Z24	45x25	25	RONZ24A2	V600-8206582

Ø (mm)	Dimensions (mm)	Boîtage	Code	Référence
Z2,5	5x2,7	500	RONZ2,5A2	V600-8206581
Z27	48x28	10	RONZ27A2	V600-8206580
Z30	52x31	10	RONZ30A2	V600-8206579

TIGE FILETÉE 1M A2



Ø (mm)	Longueur (mm)	Code	Référence
2,5	1000	TF1M2,5A2	V600-8207210
3	1000	TF1M3A2	V600-8204761
4	1000	TF1M4A2	V600-8204759
5	1000	TF1M5A2	V600-8204758
6	1000	TF1M6A2	V600-8204756
8	1000	TF1M8A2	V600-8204757
10	1000	TF1M10A2	V600-8204755
12	1000	TF1M12A2	V600-8204754
14	1000	TF1M14A2	V600-8204753
16	1000	TF1M16A2	V600-8204751

Ø (mm)	Longueur (mm)	Code	Référence
18	1000	TF1M18A2	V600-8204752
20	1000	TF1M20A2	V600-8204750
22	1000	TF1M22A2	V600-8204749
24	1000	TF1M24A2	V600-8204748
27	1000	TF1M27A2	V600-8207209
30	1000	TF1M30A2	V600-8204747
36	1000	TF1M36A2	V600-8207208
39	1000	TF1M39A2	V600-8207207
45	1000	TF1M45A2	V600-8207206

Autres dimensions disponibles sur demande.

Habillez votre magasin avec tout l'équipement GISS spécial visserie !



Rayonnage à tablettes tôlées



Bacs à bec

Pour un devis, contactez votre agence.

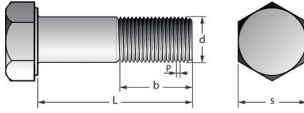

Dimensions ØxL (mm)	Filetage	Clé	Boîtage	Code	Référence
2x5	Total	4	1000	TH2X5EFA2	V600-8206824
2x6	Total	4	500	TH2X6EFA2	V600-8204421
2x8	Total	4	1000	TH2X8EFA2	V600-8206823
2x10	Total	4	1000	TH2X10EFA2	V600-8206826
2x20	Total	4	1000	TH2X20EFA2	V600-8206825
2,5x16	Total	4	1000	TH2,5X16EFA2	V600-8206811
2,5x20	Total	4	1000	TH2,5X20EFA2	V600-8206810
3x5	Total	5.5	1000	TH3X5EFA2	V600-8206807
3x6	Total	5.5	1000	TH3X6EFA2	V600-8206806
3X8	Total	5.5	500	TH3X8EFA2	V600-8204422
3X10	Total	5.5	500	TH3X10EFA2	V600-8204420
3x12	Total	5.5	1000	TH3X12EFA2	V600-8206809
3X16	Total	5.5	500	TH3X16EFA2	V600-8204419
3X20	Total	5.5	500	TH3X20EFA2	V600-8204417
3X25	Total	5.5	500	TH3X25EFA2	V600-8204418
3X30	Total	5.5	500	TH3X30EFA2	V600-8204416
3x35	Total	5.5	500	TH3X35EFA2	V600-8206808
3X40	Total	5.5	500	TH3X40EFA2	V600-8204415
4x6	Total	7	1000	TH4X6EFA2	V600-8206802
4X8	Total	7	500	TH4X8EFA2	V600-8204413
4X10	Total	7	500	TH4X10EFA2	V600-8204414
4X12	Total	7	500	TH4X12EFA2	V600-8204412
4x14	Total	7	1000	TH4X14EFA2	V600-8206804
4X16	Total	7	500	TH4X16EFA2	V600-8204411
4X20	Total	7	500	TH4X20EFA2	V600-8204410
4X25	Total	7	500	TH4X25EFA2	V600-8204409
4X30	Total	7	500	TH4X30EFA2	V600-8204408
4X35	Total	7	200	TH4X35EFA2	V600-8204407
4X40	Total	7	200	TH4X40EFA2	V600-8204406
4x45	Total	7	200	TH4X45EFA2	V600-8206803
4X50	Total	7	200	TH4X50EFA2	V600-8204405
4X60	Total	7	100	TH4X60EFA2	V600-8204404
4x70	Total	7	100	TH4X70EFA2	V600-8206801
5x6	Total	8	500	TH5X6EFA2	V600-8206798
5X8	Total	8	500	TH5X8EFA2	V600-8204402
5X10	Total	8	500	TH5X10EFA2	V600-8204403
5X12	Total	8	500	TH5X12EFA2	V600-8204401
5x14	Total	8	500	TH5X14EFA2	V600-8206800
5X16	Total	8	500	TH5X16EFA2	V600-8204400
5X20	Total	8	500	TH5X20EFA2	V600-8204399
5X25	Total	8	200	TH5X25EFA2	V600-8204398
5X30	Total	8	200	TH5X30EFA2	V600-8204397
5X35	Total	8	200	TH5X35EFA2	V600-8204396
5X40	Total	8	200	TH5X40EFA2	V600-8204395
5X45	Total	8	200	TH5X45EFA2	V600-8204394
5X50	Total	8	200	TH5X50EFA2	V600-8204393
5x55	Total	8	200	TH5X55EFA2	V600-8206799
5X60	Total	8	200	TH5X60EFA2	V600-8204392
5X70	Total	8	100	TH5X70EFA2	V600-8204391
5x80	Total	8	100	TH5X80EFA2	V600-8206797
6X8	Total	10	500	TH6X8EFA2	V600-8204390
6X10	Total	10	200	TH6X10EFA2	V600-8204388
6X12	Total	10	200	TH6X12EFA2	V600-8204387
6X14	Total	10	200	TH6X14EFA2	V600-8204389
6X16	Total	10	200	TH6X16EFA2	V600-8204386

Dimensions ØxL (mm)	Filetage	Clé	Boîtage	Code	Référence
6X18	Total	10	200	TH6X18EFA2	V600-8204385
6X20	Total	10	200	TH6X20EFA2	V600-8204384
6X25	Total	10	200	TH6X25EFA2	V600-8204382
6X30	Total	10	200	TH6X30EFA2	V600-8204383
6X35	Total	10	200	TH6X35EFA2	V600-8204380
6X40	Total	10	200	TH6X40EFA2	V600-8204379
6X45	Total	10	100	TH6X45EFA2	V600-8204378
6X50	Total	10	100	TH6X50EFA2	V600-8204376
6x55	Total	10	100	TH6X55EFA2	V600-8206795
6X60	Total	10	100	TH6X60EFA2	V600-8204375
6X65	Total	10	100	TH6X65EFA2	V600-8204374
6X70	Total	10	100	TH6X70EFA2	V600-8204372
6X80	Total	10	100	TH6X80EFA2	V600-8204371
6X90	Total	10	100	TH6X90EFA2	V600-8204369
6x100	Total	10	100	TH6X100EFA2	V600-8206796
8X10	Total	13	500	TH8X10EFA2	V600-8204368
8X12	Total	13	500	TH8X12EFA2	V600-8204366
8x14	Total	13	200	TH8X14EFA2	V600-8206792
8X16	Total	13	200	TH8X16EFA2	V600-8204367
8X20	Total	13	200	TH8X20EFA2	V600-8204365
8x22	Total	13	200	TH8X22EFA2	V600-8206789
8X25	Total	13	100	TH8X25EFA2	V600-8204363
8X30	Total	13	100	TH8X30EFA2	V600-8204364
8X40	Total	13	100	TH8X40EFA2	V600-8204360
8X35	Total	13	100	TH8X35EFA2	V600-8204361
8X50	Total	13	100	TH8X50EFA2	V600-8204357
8X60	Total	13	100	TH8X60EFA2	V600-8204355
8X65	Total	13	100	TH8X65EFA2	V600-8204352
8X55	Total	13	100	TH8X55EFA2	V600-8204356
8X70	Total	13	50	TH8X70EFA2	V600-8204353
8x75	Total	13	50	TH8X75EFA2	V600-8206788
8X80	Total	13	50	TH8X80EFA2	V600-8204350
8X90	Total	13	50	TH8X90EFA2	V600-8204349
8X100	Total	13	50	TH8X100EFA2	V600-8204348
8x110	Total	13	50	TH8X110EFA2	V600-8206794
8X120	Total	13	50	TH8X120EFA2	V600-8204347
8x130	Total	13	50	TH8X130EFA2	V600-8206793
8x140	Total	13	50	TH8X140EFA2	V600-8206791
8x150	Total	13	50	TH8X150EFA2	V600-8206790
10x10	Total	17	100	TH10X10EFA2	V600-8206844
10x12	Total	17	50	TH10X12EFA2	V600-8206842
10X16	Total	17	100	TH10X16EFA2	V600-8204345
10X20	Total	17	100	TH10X20EFA2	V600-8204343
10X25	Total	17	100	TH10X25EFA2	V600-8204342
10X30	Total	17	100	TH10X30EFA2	V600-8204341
10X35	Total	17	100	TH10X35EFA2	V600-8204340
10X40	Total	17	100	TH10X40EFA2	V600-8204339
10X45	Total	17	100	TH10X45EFA2	V600-8204338
10X50	Total	17	50	TH10X50EFA2	V600-8204337
10X55	Total	17	50	TH10X55EFA2	V600-8204336
10X60	Total	17	50	TH10X60EFA2	V600-8204335
10X65	Total	17	50	TH10X65EFA2	V600-8204332
10X70	Total	17	50	TH10X70EFA2	V600-8204331
10x75	Total	17	50	TH10X75EFA2	V600-8206843
10X80	Total	17	50	TH10X80EFA2	V600-8204330

(Suite) VIS TÊTE HEXAGONALE

Dimensions ØxL (mm)	Filetage	Clé	Boîtage	Code	Référence
10x90	Total	17	50	TH10X90EFA2	V600-8204328
10x100	Total	17	50	TH10X100EFA2	V600-8204326
10x120	Total	17	50	TH10X120EFA2	V600-8204327
10x110	Total	17	50	TH10X110EFA2	V600-8207251
10x150	Total	17	50	TH10X150EFA2	V600-8207250
10x160	Total	17	50	TH10X160EFA2	V600-8207249
12x16	Total	19	50	TH12X16EFA2	V600-8206841
12X20	Total	19	100	TH12X20EFA2	V600-8204324
12X25	Total	19	50	TH12X25EFA2	V600-8204323
12X30	Total	19	100	TH12X30EFA2	V600-8204321
12X35	Total	19	100	TH12X35EFA2	V600-8204322
12X40	Total	19	50	TH12X40EFA2	V600-8204319
12X45	Total	19	100	TH12X45EFA2	V600-8204320
12X50	Total	19	50	TH12X50EFA2	V600-8204317
12x55	Total	19	50	TH12X55EFA2	V600-8206840
12X60	Total	19	50	TH12X60EFA2	V600-8204316
12X65	Total	19	50	TH12X65EFA2	V600-8204315
12X70	Total	19	50	TH12X70EFA2	V600-8204314
12x75	Total	19	25	TH12X75EFA2	V600-8206839
12X80	Total	19	50	TH12X80EFA2	V600-8204312
12x85	Total	19	25	TH12X85EFA2	V600-8206838
12X90	Total	19	25	TH12X90EFA2	V600-8204310
12X100	Total	19	25	TH12X100EFA2	V600-8204309
12x110	Total	19	50	TH12X110EFA2	V600-8207248
12X120	Total	19	25	TH12X120EFA2	V600-8204307
12x140	Total	19	25	TH12X140EFA2	V600-8207247
12x150	Total	19	25	TH12X150EFA2	V600-8207246
12x160	Total	19	10	TH12X160EFA2	V600-8207245
14X30	Total	22	50	TH14X30EFA2	V600-8204306
14x20	Total	22	50	TH14X20EFA2	V600-8206837
14x25	Total	22	50	TH14X25EFA2	V600-8206836
14x35	Total	22	50	TH14X35EFA2	V600-8206835
14X40	Total	22	25	TH14X40EFA2	V600-8204304
14X45	Total	22	50	TH14X45EFA2	V600-8204305
14X50	Total	22	25	TH14X50EFA2	V600-8204303
14X60	Total	22	25	TH14X60EFA2	V600-8204302
14x65	Total	22	50	TH14X65EFA2	V600-8206834
14X70	Total	22	50	TH14X70EFA2	V600-8204301
14X80	Total	22	25	TH14X80EFA2	V600-8204300
14x90	Total	22	50	TH14X90EFA2	V600-8206833
14x100	Total	22	50	TH14X100EFA2	V600-8207244
14x110	Total	22	25	TH14X110EFA2	V600-8207243
14x120	Total	22	25	TH14X120EFA2	V600-8207242
14x140	Total	22	25	TH14X140EFA2	V600-8207241
16x20	Total	24	25	TH16X20EFA2	V600-8206832
16X25	Total	24	25	TH16X25EFA2	V600-8204299
16X30	Total	24	25	TH16X30EFA2	V600-8204298
16X35	Total	24	25	TH16X35EFA2	V600-8204297
16X40	Total	24	25	TH16X40EFA2	V600-8204295
16x45	Total	24	25	TH16X45EFA2	V600-8206831
16X50	Total	24	25	TH16X50EFA2	V600-8204296
16x55	Total	24	25	TH16X55EFA2	V600-8206830
16X60	Total	24	25	TH16X60EFA2	V600-8204294
16x65	Total	24	25	TH16X65EFA2	V600-8206829
16X70	Total	24	25	TH16X70EFA2	V600-8204292
16X80	Total	24	25	TH16X80EFA2	V600-8204290
16X90	Total	24	25	TH16X90EFA2	V600-8204288
16X100	Total	24	25	TH16X100EFA2	V600-8204287
16x110	Total	24	25	TH16X110EFA2	V600-8207240
16X120	Total	24	25	TH16X120EFA2	V600-8204284
16x130	Total	24	25	TH16X130EFA2	V600-8207239
16X140	Total	24	25	TH16X140EFA2	V600-8204285
16x150	Total	24	25	TH16X150EFA2	V600-8207238

Dimensions ØxL (mm)	Filetage	Clé	Boîtage	Code	Référence
16x160	Total	24	25	TH16X160EFA2	V600-8207237
16X200	Total	24	10	TH16X200EFA2	V600-8204283
18X40	Total	27	25	TH18X40EFA2	V600-8204282
18X50	Total	27	25	TH18X50EFA2	V600-8204281
18x60	Total	27	25	TH18X60EFA2	V600-8206828
18X70	Total	27	25	TH18X70EFA2	V600-8204278
18X80	Total	27	25	TH18X80EFA2	V600-8204280
18x90	Total	27	25	TH18X90EFA2	V600-8206827
18x100	Total	27	25	TH18X100EFA2	V600-8207236
18x120	Total	27	25	TH18X120EFA2	V600-8207235
20x35	Total	30	25	TH20X35EFA2	V600-8206822
20X40	Total	30	25	TH20X40EFA2	V600-8204277
20X45	Total	30	25	TH20X45EFA2	V600-8204279
20X50	Total	30	25	TH20X50EFA2	V600-8204276
20x55	Total	30	25	TH20X55EFA2	V600-8206821
20X60	Total	30	25	TH20X60EFA2	V600-8204275
20X70	Total	30	25	TH20X70EFA2	V600-8204274
20X80	Total	30	25	TH20X80EFA2	V600-8204273
20X90	Total	30	25	TH20X90EFA2	V600-8204272
20X100	Total	30	25	TH20X100EFA2	V600-8204271
20x110	Total	30	25	TH20X110EFA2	V600-8207234
20x120	Total	30	25	TH20X120EFA2	V600-8207233
20x130	Total	30	25	TH20X130EFA2	V600-8207232
20x140	Total	30	25	TH20X140EFA2	V600-8207231
20x150	Total	30	25	TH20X150EFA2	V600-8207230
20x160	Total	30	25	TH20X160EFA2	V600-8207229
20x170	Total	30	10	TH20X170EFA2	V600-8207261
20x180	Total	30	20	TH20X180EFA2	V600-8207228
20x200	Total	30	20	TH20X200EFA2	V600-8207227
22x40	Total	33	25	TH22X40EFA2	V600-8206820
22x55	Total	33	25	TH22X55EFA2	V600-8206819
22x60	Total	33	25	TH22X60EFA2	V600-8206818
22x70	Total	33	25	TH22X70EFA2	V600-8206817
22x90	Total	33	25	TH22X90EFA2	V600-8206816
22x100	Total	33	25	TH22X100EFA2	V600-8207226
22x130	Total	33	20	TH22X130EFA2	V600-8207225
24x50	Total	36	10	TH24X50EFA2	V600-8206815
24x60	Total	36	10	TH24X60EFA2	V600-8206814
24x80	Total	36	10	TH24X80EFA2	V600-8206813
24x90	Total	36	10	TH24X90EFA2	V600-8206812
24x100	Total	36	10	TH24X100EFA2	V600-8207224
24x110	Total	36	10	TH24X110EFA2	V600-8207223
24x120	Total	36	10	TH24X120EFA2	V600-8207222
24x130	Total	36	10	TH24X130EFA2	V600-8207221
24x140	Total	36	10	TH24X140EFA2	V600-8207220
24x160	Total	36	10	TH24X160EFA2	V600-8207219
27x110	Total	41	10	TH27X110EFA2	V600-8207218
27x130	Total	41	10	TH27X130EFA2	V600-8207217
27x140	Total	41	10	TH27X140EFA2	V600-8207216
30x90	Total	46	10	TH30X90EFA2	V600-8206805
30x120	Total	46	10	TH30X120EFA2	V600-8207215
30x150	Total	46	10	TH30X150EFA2	V600-8207214
33x150	Total	50	5	TH33X150EFA2	V600-8207213
36x140	Total	55	5	TH36X140EFA2	V600-8207212
5x25	Partiel	8	200	TH5X25PFA2	V600-8206863
5x30	Partiel	8	200	TH5X30PFA2	V600-8206862
5x45	Partiel	8	200	TH5X45PFA2	V600-8206861
5x50	Partiel	8	200	TH5X50PFA2	V600-8206860
5x55	Partiel	8	200	TH5X55PFA2	V600-8206859
5x70	Partiel	8	100	TH5X70PFA2	V600-8206858
6x30	Partiel	10	200	TH6X30PFA2	V600-8206856
6X35	Partiel	10	200	TH6X35PFA2	V600-8204381
6x40	Partiel	10	200	TH6X40PFA2	V600-8206855

(Suite) VIS TÊTE HEXAGONALE

Dimensions ØxL (mm)	Filetage	Clé	Boftage	Code	Référence
6x50	Partiel	10	100	TH6X50PFA2	V600-8206854
6x55	Partiel	10	100	TH6X55PFA2	V600-8204377
6x60	Partiel	10	100	TH6X60PFA2	V600-8204373
6x70	Partiel	10	100	TH6X70PFA2	V600-8204370
6x150	Partiel	10	100	TH6X150PFA2	V600-8206857
8x30	Partiel	13	100	TH8X30PFA2	V600-8206851
8x40	Partiel	13	100	TH8X40PFA2	V600-8204359
8x45	Partiel	13	100	TH8X45PFA2	V600-8206850
8x50	Partiel	13	100	TH8X50PFA2	V600-8206849
8x60	Partiel	13	100	TH8X60PFA2	V600-8204354
8x65	Partiel	13	100	TH8X65PFA2	V600-8206848
8x70	Partiel	13	50	TH8X70PFA2	V600-8204351
8x80	Partiel	13	50	TH8X80PFA2	V600-8206847
8x90	Partiel	13	50	TH8X90PFA2	V600-8206846
8x100	Partiel	13	50	TH8X100PFA2	V600-8204346
8x120	Partiel	13	50	TH8X120PFA2	V600-8204344
8x140	Partiel	13	50	TH8X140PFA2	V600-8206853
8x220	Partiel	13	25	TH8X220PFA2	V600-8206852
10x35	Partiel	17	100	TH10X35PFA2	V600-8206886
10x40	Partiel	17	100	TH10X40PFA2	V600-8206885
10x45	Partiel	17	100	TH10X45PFA2	V600-8206884
10x50	Partiel	17	50	TH10X50PFA2	V600-8206883
10x55	Partiel	17	50	TH10X55PFA2	V600-8206882
10x60	Partiel	17	50	TH10X60PFA2	V600-8204334
10x65	Partiel	17	50	TH10X65PFA2	V600-8204333
10x70	Partiel	17	50	TH10X70PFA2	V600-8206881
10x80	Partiel	17	50	TH10X80PFA2	V600-8204329
10x90	Partiel	17	50	TH10X90PFA2	V600-8206880
10x110	Partiel	17	50	TH10X110PFA2	V600-8207291
10x130	Partiel	17	50	TH10X130PFA2	V600-8204325
10x150	Partiel	17	50	TH10X150PFA2	V600-8207290
10x160	Partiel	17	25	TH10X160PFA2	V600-8207289
10x220	Partiel	17	10	TH10X220PFA2	V600-8207288
12x40	Partiel	19	50	TH12X40PFA2	V600-8206879
12x50	Partiel	19	50	TH12X50PFA2	V600-8204318
12x55	Partiel	19	50	TH12X55PFA2	V600-8206878
12x70	Partiel	19	50	TH12X70PFA2	V600-8204313
12x80	Partiel	19	25	TH12X80PFA2	V600-8204311
12x90	Partiel	19	25	TH12X90PFA2	V600-8206877
12x100	Partiel	19	25	TH12X100PFA2	V600-8207287
12x110	Partiel	19	25	TH12X110PFA2	V600-8204308
12x120	Partiel	19	25	TH12X120PFA2	V600-8207286
12x130	Partiel	19	25	TH12X130PFA2	V600-8207285
12x150	Partiel	19	25	TH12X150PFA2	V600-8207284
12x160	Partiel	19	10	TH12X160PFA2	V600-8207283

Dimensions ØxL (mm)	Filetage	Clé	Boftage	Code	Référence
12x170	Partiel	19	10	TH12X170PFA2	V600-8207282
12x180	Partiel	19	10	TH12X180PFA2	V600-8207281
12x200	Partiel	19	10	TH12X200PFA2	V600-8207280
14x50	Partiel	22	50	TH14X50PFA2	V600-8206876
14x60	Partiel	22	50	TH14X60PFA2	V600-8206875
14x70	Partiel	22	50	TH14X70PFA2	V600-8206874
14x80	Partiel	22	25	TH14X80PFA2	V600-8206873
14x100	Partiel	22	25	TH14X100PFA2	V600-8207279
14x120	Partiel	22	25	TH14X120PFA2	V600-8207278
16x50	Partiel	24	25	TH16X50PFA2	V600-8206872
16x60	Partiel	24	25	TH16X60PFA2	V600-8204293
16x70	Partiel	24	25	TH16X70PFA2	V600-8204291
16x80	Partiel	24	25	TH16X80PFA2	V600-8204289
16x100	Partiel	24	25	TH16X100PFA2	V600-8207277
16x110	Partiel	24	25	TH16X110PFA2	V600-8204286
16x140	Partiel	24	25	TH16X140PFA2	V600-8207276
16x160	Partiel	24	10	TH16X160PFA2	V600-8207275
16x180	Partiel	24	10	TH16X180PFA2	V600-8207274
16x200	Partiel	24	10	TH16X200PFA2	V600-8207273
18x60	Partiel	27	25	TH18X60PFA2	V600-8206871
18x70	Partiel	27	25	TH18X70PFA2	V600-8206870
18x80	Partiel	27	25	TH18X80PFA2	V600-8206869
18x100	Partiel	27	25	TH18X100PFA2	V600-8207272
18x110	Partiel	27	25	TH18X110PFA2	V600-8207271
18x120	Partiel	27	25	TH18X120PFA2	V600-8207270
18x130	Partiel	27	25	TH18X130PFA2	V600-8207269
18x160	Partiel	27	25	TH18X160PFA2	V600-8207268
20x70	Partiel	30	25	TH20X70PFA2	V600-8206868
20x75	Partiel	30	25	TH20X75PFA2	V600-8206867
20x80	Partiel	30	25	TH20X80PFA2	V600-8206866
20x90	Partiel	30	25	TH20X90PFA2	V600-8206865
20x100	Partiel	30	25	TH20X100PFA2	V600-8204270
20x110	Partiel	30	25	TH20X110PFA2	V600-8207267
20x120	Partiel	30	25	TH20X120PFA2	V600-8207266
20x130	Partiel	30	25	TH20X130PFA2	V600-8207265
20x140	Partiel	30	25	TH20X140PFA2	V600-8207264
20x150	Partiel	30	25	TH20X150PFA2	V600-8207263
20x160	Partiel	30	10	TH20X160PFA2	V600-8207262
20x210	Partiel	30	10	TH20X210PFA2	V600-8207260
20x230	Partiel	30	10	TH20X230PFA2	V600-8207259
20x240	Partiel	30	10	TH20X240PFA2	V600-8207258
24x90	Partiel	36	10	TH24X90PFA2	V600-8206864
24x150	Partiel	36	10	TH24X150PFA2	V600-8207254
30x140	Partiel	46	10	TH30X140PFA2	V600-8207253
30x240	Partiel	46	5	TH30X240PFA2	V600-8207252

Autres dimensions disponibles sur demande.

Réapprovisionnez
votre visserie avec
notre solution scan !



NOUVEAU

- Depuis notre appli mobile Rubix
- Réapro simple et rapide
- Historique des commandes
- Suivi des livraisons



VIS STHC - VIS SANS TÊTE HEXAGONALE CREUSE BOUT PLAT



DIN
913

ISO
4026

A2

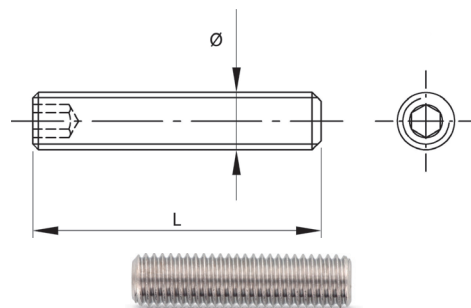

Dimensions ØxL (mm)	Filetage	Clé	Boîtage	Code	Référence
2X2	Total	0,9	500	STHCPLA2X2EFA2	V600-8205170
3X3	Total	1,5	500	STHCPLA3X3EFA2	V600-8204636
3X4	Total	1,5	500	STHCPLA3X4EFA2	V600-8204634
3X6	Total	1,5	500	STHCPLA3X6EFA2	V600-8204632
3X10	Total	1,5	500	STHCPLA3X10EFA2	V600-8204633
3X12	Total	1,5	500	STHCPLA3X12EFA2	V600-8204631
4X5	Total	2	500	STHCPLA4X5EFA2	V600-8204630
4X6	Total	2	500	STHCPLA4X6EFA2	V600-8204629
4X8	Total	2	500	STHCPLA4X8EFA2	V600-8204628
4X10	Total	2	500	STHCPLA4X10EFA2	V600-8204627
4X12	Total	2	500	STHCPLA4X12EFA2	V600-8204626
4X16	Total	2	500	STHCPLA4X16EFA2	V600-8204625
4X20	Total	2	500	STHCPLA4X20EFA2	V600-8204624
5X5	Total	2,5	500	STHCPLA5X5EFA2	V600-8204623
5X6	Total	2,5	500	STHCPLA5X6EFA2	V600-8204622
5X8	Total	2,5	500	STHCPLA5X8EFA2	V600-8204621
5X10	Total	2,5	500	STHCPLA5X10EFA2	V600-8204620

Dimensions ØxL (mm)	Filetage	Clé	Boîtage	Code	Référence
5X12	Total	2,5	500	STHCPLA5X12EFA2	V600-8204619
6X5	Total	3	200	STHCPLA6X5EFA2	V600-8204618
6X8	Total	3	200	STHCPLA6X8EFA2	V600-8204617
6X10	Total	3	200	STHCPLA6X10EFA2	V600-8204616
6X12	Total	3	200	STHCPLA6X12EFA2	V600-8204615
6X16	Total	3	200	STHCPLA6X16EFA2	V600-8204614
6X25	Total	3	200	STHCPLA6X25EFA2	V600-8204612
6X60	Total	3	200	STHCPLA6X60EFA2	V600-8204611
8X8	Total	4	200	STHCPLA8X8EFA2	V600-8204610
8X10	Total	4	200	STHCPLA8X10EFA2	V600-8204609
8X12	Total	4	200	STHCPLA8X12EFA2	V600-8204608
8X20	Total	4	200	STHCPLA8X20EFA2	V600-8204607
10X12	Total	5	200	STHCPLA10X12EFA2	V600-8204606
10X20	Total	5	200	STHCPLA10X20EFA2	V600-8204605
10X35	Total	5	100	STHCPLA10X35EFA2	V600-8204952
10X50	Total	5	100	STHCPLA10X50EFA2	V600-8204951

Autres dimensions disponibles sur demande.

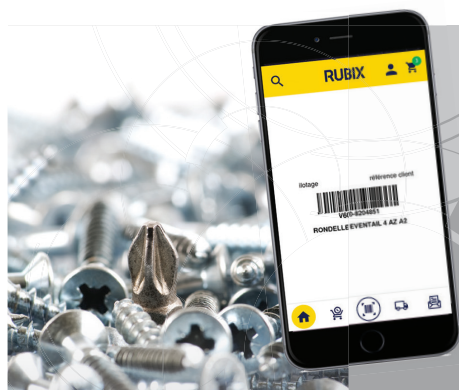

X Scannez et commandez !

Facilitez votre réassort en utilisant notre solution de scan ou notre application mobile Rubix.

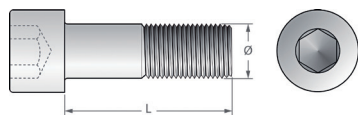

Dimensions ØxL (mm)	Filetage	Clé	Boîtage	Code	Référence
2X3	Total	1.5	500	CHC2X3EFA2	V600-8204591
2X4	Total	1.5	500	CHC2X4EFA2	V600-8204590
2X5	Total	1.5	500	CHC2X5EFA2	V600-8204589
2X6	Total	1.5	500	CHC2X6EFA2	V600-8204950
2X8	Total	1.5	500	CHC2X8EFA2	V600-8204949
2X10	Total	1.5	500	CHC2X10EFA2	V600-8204958
2X12	Total	1.5	500	CHC2X12EFA2	V600-8204588
2x14	Total	1,5	500	CHC2X14EFA2	V600-8206941
2x16	Total	1,5	500	CHC2X16EFA2	V600-8206940
2x20	Total	1,5	500	CHC2X20EFA2	V600-8206939
2,5X4	Total	2	500	CHC2,5X4EFA2	V600-8204587
2,5X5	Total	2	500	CHC2,5X5EFA2	V600-8204584
2,5X6	Total	2	500	CHC2,5X6EFA2	V600-8204583
2,5X8	Total	2	500	CHC2,5X8EFA2	V600-8204585
2,5X10	Total	2	500	CHC2,5X10EFA2	V600-8204582
2,5X12	Total	2	500	CHC2,5X12EFA2	V600-8204581
2,5X16	Total	2	500	CHC2,5X16EFA2	V600-8204580
2,5X20	Total	2	500	CHC2,5X20EFA2	V600-8204579
2,5X25	Total	2	500	CHC2,5X25EFA2	V600-8204578
3x4	Total	2.5	1000	CHC3X4EFA2	V600-8206928
3X5	Total	2.5	500	CHC3X5EFA2	V600-8204586
3X6	Total	2.5	500	CHC3X6EFA2	V600-8204576
3X8	Total	2.5	500	CHC3X8EFA2	V600-8204577
3X10	Total	2.5	500	CHC3X10EFA2	V600-8204575
3X12	Total	2.5	500	CHC3X12EFA2	V600-8204574
3X14	Total	2.5	500	CHC3X14EFA2	V600-8204573
3X16	Total	2.5	500	CHC3X16EFA2	V600-8204572
3x18	Total	2.5	1000	CHC3X18EFA2	V600-8206929
3X20	Total	2.5	500	CHC3X20EFA2	V600-8204571
3X25	Partiel	2.5	500	CHC3X25PFA2	V600-8204527
3X30	Partiel	2.5	500	CHC3X30PFA2	V600-8204528
3X35	Partiel	2.5	500	CHC3X35PFA2	V600-8204526
3X40	Partiel	2.5	500	CHC3X40PFA2	V600-8204525
3X50	Partiel	2.5	200	CHC3X50PFA2	V600-8204524
3x60	Partiel	2.5	200	CHC3X60PFA2	V600-8206927
4x4	Total	3	1000	CHC4X4EFA2	V600-8206924
4X6	Total	3	500	CHC4X6EFA2	V600-8204570
4X8	Total	3	500	CHC4X8EFA2	V600-8204569
4X10	Total	3	500	CHC4X10EFA2	V600-8204568
4x10	Partiel	3	1000	CHCTC4X10PFA2DIN6912	V600-8206490
4X12	Total	3	500	CHC4X12EFA2	V600-8204566
4x12	Partiel	3	1000	CHCTC4X12PFA2DIN6912	V600-8206489
4X14	Total	3	500	CHC4X14EFA2	V600-8204567
4X16	Total	3	500	CHC4X16EFA2	V600-8204565
4x16	Partiel	3	1000	CHCTC4X16PFA2DIN6912	V600-8206488
4x18	Total	3	1000	CHC4X18EFA2	V600-8206926
4X20	Total	3	500	CHC4X20EFA2	V600-8204564
4x22	Total	3	500	CHC4X22EFA2	V600-8206925
4X25	Total	3	500	CHC4X25EFA2	V600-8204563
4X30	Partiel	3	500	CHC4X30PFA2	V600-8204523
4X35	Partiel	3	200	CHC4X35PFA2	V600-8204522
4X40	Partiel	3	200	CHC4X40PFA2	V600-8204521
4X45	Partiel	3	200	CHC4X45PFA2	V600-8204520
4X50	Partiel	3	200	CHC4X50PFA2	V600-8204518
4x60	Partiel	3	100	CHC4X60PFA2	V600-8206923
4x70	Partiel	3	100	CHC4X70PFA2	V600-8206922
4X80	Partiel	3	100	CHC4X80PFA2	V600-8204519
5X6	Total	4	500	CHC5X6EFA2	V600-8204562

Dimensions ØxL (mm)	Filetage	Clé	Boîtage	Code	Référence
5X8	Total	4	500	CHC5X8EFA2	V600-8204561
5X10	Total	4	500	CHC5X10EFA2	V600-8204560
5x10	Partiel	4	1000	CHCTC5X10PFA2DIN6912	V600-8206487
5x10	Total	4	500	CHCTC5X12EFA2DIN6912	V600-8206486
5X12	Total	4	500	CHC5X12EFA2	V600-8204559
5X14	Total	4	500	CHC5X14EFA2	V600-8204558
5X16	Total	4	500	CHC5X16EFA2	V600-8204557
5x16	Partiel	4	500	CHCTC5X16PFA2DIN6912	V600-8206485
5x18	Total	4	500	CHC5X18EFA2	V600-8206920
5X20	Total	4	500	CHC5X20EFA2	V600-8204556
5x20	Partiel	4	500	CHCTC5X20PFA2DIN6912	V600-8206484
5x22	Total	4	500	CHC5X22EFA2	V600-8206919
5X25	Partiel	4	200	CHC5X25PFA2	V600-8204517
5X30	Partiel	4	500	CHC5X30PFA2	V600-8204516
5X35	Partiel	4	200	CHC5X35PFA2	V600-8204515
5X40	Partiel	4	500	CHC5X40PFA2	V600-8204514
5x40	Total	4	200	CHCTC5X40EFA2DIN6912	V600-8206483
5X45	Partiel	4	200	CHC5X45PFA2	V600-8204513
5X50	Partiel	4	200	CHC5X50PFA2	V600-8204512
5x55	Partiel	4	200	CHC5X55PFA2	V600-8206918
5X60	Partiel	4	100	CHC5X60PFA2	V600-8204511
5x65	Partiel	4	100	CHC5X65PFA2	V600-8206917
5X70	Partiel	4	100	CHC5X70PFA2	V600-8204510
5X80	Partiel	4	100	CHC5X80PFA2	V600-8204509
5X90	Partiel	4	100	CHC5X90PFA2	V600-8206916
5x100	Partiel	4	100	CHC5X100PFA2	V600-8206921
6X8	Total	5	500	CHC6X8EFA2	V600-8204555
6X10	Total	5	500	CHC6X10EFA2	V600-8204554
6x10	Partiel	5	500	CHCTC6X10PFA2DIN6912	V600-8206482
6x12	Partiel	5	500	CHCTC6X12PFA2DIN6912	V600-8206481
6X12	Total	5	500	CHC6X12EFA2	V600-8204552
6X14	Total	5	200	CHC6X14EFA2	V600-8204553
6X16	Total	5	200	CHC6X16EFA2	V600-8204551
6x18	Total	5	200	CHC6X18EFA2	V600-8206911
6X20	Total	5	200	CHC6X20EFA2	V600-8204550
6X20	Total	5	200	CHCTC6X20EFA2DIN6912	V600-8206479
6x22	Total	5	200	CHC6X22EFA2	V600-8206910
6X25	Total	5	200	CHC6X25EFA2	V600-8204549
6X30	Total	5	200	CHC6X30EFA2	V600-8204548
6X35	Partiel	5	200	CHC6X35PFA2	V600-8204507
6X40	Partiel	5	200	CHC6X40PFA2	V600-8204508
6X45	Partiel	5	100	CHC6X45PFA2	V600-8204506
6X50	Partiel	5	100	CHC6X50PFA2	V600-8204504
6x55	Partiel	5	100	CHC6X55PFA2	V600-8206909
6X60	Partiel	5	100	CHC6X60PFA2	V600-8204505
6x65	Partiel	5	100	CHC6X65PFA2	V600-8206908
6X70	Partiel	5	100	CHC6X70PFA2	V600-8204502
6x75	Partiel	5	100	CHC6X75PFA2	V600-8206907
6X80	Partiel	5	100	CHC6X80PFA2	V600-8204503
6x90	Partiel	5	100	CHC6X90PFA2	V600-8206906
6X100	Partiel	5	100	CHC6X100PFA2	V600-8204500
6x110	Partiel	5	100	CHC6X110PFA2	V600-8206915
6x120	Partiel	5	100	CHC6X120PFA2	V600-8206914
6x130	Partiel	5	100	CHC6X130PFA2	V600-8206913
6x140	Partiel	5	100	CHC6X140PFA2	V600-8206912
6x150	Partiel	5	100	CHC6X150PFA2	V600-8209235
8X10	Total	6	500	CHC8X10EFA2	V600-8204547
8X12	Partiel	6	500	CHC8X12PFA2	V600-8204501

(Suite) VIS CHC - TÊTE CYLINDRIQUE HEXAGONALE CREUSE

Dimensions ØxL (mm)	Filetage	Clé	Boîtage	Code	Référence
8x14	Total	6	200	CHC8X14EFA2	V600-8206903
8X16	Total	6	200	CHC8X16EFA2	V600-8204546
8x16	Partiel	6	200	CHCTC8X16PFA2DIN6912	V600-8206478
8x18	Partiel	6	200	CHC8X18PFA2	V600-8206900
8X20	Total	6	200	CHC8X20EFA2	V600-8204545
8X20	Total	6	200	CHCTC8X20EFA2DIN6912	V600-8206477
8x22	Total	6	200	CHC8X22EFA2	V600-8206899
8X25	Total	6	200	CHC8X25EFA2	V600-8204543
8x25	Partiel	6	100	CHCTC8X25PFA2DIN6912	V600-8206476
8X30	Total	6	200	CHC8X30EFA2	V600-8204544
8X35	Total	6	100	CHC8X35EFA2	V600-8204542
8x35	Partiel	6	100	CHCTC8X35PFA2DIN6912	V600-8206475
8X40	Partiel	6	200	CHC8X40PFA2	V600-8204498
8X45	Partiel	6	100	CHC8X45PFA2	V600-8204499
8X45	Partiel	6	100	CHCTC8X45PFA2DIN6912	V600-8206474
8X50	Partiel	6	100	CHC8X50PFA2	V600-8204497
8x55	Partiel	6	100	CHC8X55PFA2	V600-8206898
8X60	Partiel	6	100	CHC8X60PFA2	V600-8204496
8X70	Partiel	6	100	CHC8X70PFA2	V600-8204495
8X80	Partiel	6	100	CHC8X80PFA2	V600-8204494
8X90	Partiel	6	100	CHC8X90PFA2	V600-8204493
8X100	Partiel	6	50	CHC8X100PFA2	V600-8204491
8x110	Partiel	6	50	CHC8X110PFA2	V600-8206905
8x120	Partiel	6	50	CHC8X120PFA2	V600-8206904
8x130	Partiel	6	50	CHC8X130PFA2	V600-8209234
8x140	Partiel	6	50	CHC8X140PFA2	V600-8206902
8x150	Partiel	6	50	CHC8X150PFA2	V600-8206901
10X16	Total	8	100	CHC10X16EFA2	V600-8204541
10X20	Total	8	100	CHC10X20EFA2	V600-8204540
10X25	Total	8	100	CHC10X25EFA2	V600-8204538
10X30	Total	8	100	CHC10X30EFA2	V600-8204539
10X35	Total	8	100	CHC10X35EFA2	V600-8204535
10X40	Total	8	100	CHC10X40EFA2	V600-8204492
10x45	Partiel	8	100	CHC10X45PFA2	V600-8206968
10X50	Partiel	8	50	CHC10X50PFA2	V600-8204490
10x55	Partiel	8	50	CHC10X55PFA2	V600-8206967
10X60	Partiel	8	50	CHC10X60PFA2	V600-8204489
10x65	Partiel	8	25	CHC10X65PFA2	V600-8206947
10X70	Partiel	8	50	CHC10X70PFA2	V600-8204488
10X80	Partiel	8	50	CHC10X80PFA2	V600-8204537
10X100	Partiel	8	50	CHC10X100PFA2	V600-8204487
10x110	Partiel	8	50	CHC10X110PFA2	V600-8207308
10x120	Partiel	8	50	CHC10X120PFA2	V600-8207307
10x140	Partiel	8	50	CHC10X140PFA2	V600-8207306
12x16	Total	10	50	CHC12X16EFA2	V600-8206965
12X20	Total	10	50	CHC12X20EFA2	V600-8204536
12X25	Total	10	50	CHC12X25EFA2	V600-8204534
12X30	Total	10	50	CHC12X30EFA2	V600-8204533
12X35	Total	10	50	CHC12X35EFA2	V600-8204531
12X40	Total	10	50	CHC12X40EFA2	V600-8204532
12X45	Total	10	50	CHC12X45EFA2	V600-8204530
12X50	Total	10	50	CHC12X50EFA2	V600-8204486
12x55	Partiel	10	50	CHC12X55PFA2	V600-8206964

Dimensions ØxL (mm)	Filetage	Clé	Boîtage	Code	Référence
12X60	Partiel	10	50	CHC12X60PFA2	V600-8204485
12X70	Partiel	10	50	CHC12X70PFA2	V600-8204484
12x80	Partiel	10	25	CHC12X80PFA2	V600-8206963
12x90	Partiel	10	25	CHC12X90PFA2	V600-8206962
12x100	Partiel	10	25	CHC12X100PFA2	V600-8207305
12x110	Partiel	10	25	CHC12X110PFA2	V600-8207304
12x120	Partiel	10	25	CHC12X120PFA2	V600-8207303
12x130	Partiel	10	25	CHC12X130PFA2	V600-8207302
12x160	Partiel	10	25	CHC12X160PFA2	V600-8207301
14x25	Total	12	50	CHC14X25EFA2	V600-8206961
14x30	Total	12	50	CHC14X30EFA2	V600-8206960
14x35	Total	12	50	CHC14X35EFA2	V600-8206959
14x40	Total	12	50	CHC14X40EFA2	V600-8206958
14x45	Total	12	50	CHC14X45EFA2	V600-8206957
14x55	Total	12	50	CHC14X55EFA2	V600-8206956
14X50	Total	12	50	CHC14X50EFA2	V600-8204529
14X60	Partiel	12	50	CHC14X60PFA2	V600-8204483
14x70	Partiel	12	50	CHC14X70PFA2	V600-8206955
14x80	Partiel	12	50	CHC14X80PFA2	V600-8206954
14x100	Partiel	12	50	CHC14X100PFA2	V600-8207300
14x150	Partiel	12	25	CHC14X150PFA2	V600-8207299
16x20	Total	14	25	CHC16X20EFA2	V600-8206953
16x30	Total	14	25	CHC16X30EFA2	V600-8206952
16x35	Total	14	25	CHC16X35EFA2	V600-8206951
16x40	Total	14	25	CHC16X40EFA2	V600-8206950
16x45	Total	14	25	CHC16X45EFA2	V600-8206949
16X50	Partiel	14	25	CHC16X50PFA2	V600-8204482
16x55	Total	14	25	CHC16X55EFA2	V600-8206948
16X60	Partiel	14	25	CHC16X60PFA2	V600-8204481
16x70	Partiel	14	25	CHC16X70PFA2	V600-8206946
16x80	Partiel	14	25	CHC16X80PFA2	V600-8206945
16x90	Partiel	14	25	CHC16X90PFA2	V600-8206944
16x100	Partiel	14	25	CHC16X100PFA2	V600-8207298
16x140	Partiel	14	25	CHC16X140PFA2	V600-8207297
16x160	Partiel	14	25	CHC16X160PFA2	V600-8207296
18x40	Partiel	14	25	CHC18X40PFA2	V600-8206943
18x50	Partiel	14	25	CHC18X50PFA2	V600-8206942
19x90	Partiel	14	50	CHC19X90PFA2	V600-8206966
20x40	Total	14	25	CHC20X40EFA2	V600-8209238
20x50	Total	14	25	CHC20X50EFA2	V600-8206938
20x55	Total	14	25	CHC20X55EFA2	V600-8206937
20x60	Total	14	25	CHC20X60EFA2	V600-8206936
20x70	Total	14	25	CHC20X70EFA2	V600-8206935
20x90	Partiel	14	25	CHC20X90PFA2	V600-8206934
20x100	Partiel	14	25	CHC20X100PFA2	V600-8207295
22x50	Total	14	25	CHC22X50EFA2	V600-8206933
22x90	Partiel	14	25	CHC22X90PFA2	V600-8206932
24x50	Total	14	10	CHC24X50EFA2	V600-8206931
24x70	Partiel	14	10	CHC24X70PFA2	V600-8209237
24x90	Total	14	10	CHC24X90EFA2	V600-8206930
24x110	Partiel	14	10	CHC24X110PFA2	V600-8207294
24x130	Partiel	14	10	CHC24X130PFA2	V600-8207293
24x140	Partiel	14	10	CHC24X140PFA2	V600-8207292

Autres dimensions disponibles sur demande.

VIS CHC TÊTE BASSE



Dimensions ØxL (mm)	Filetage	Clé	Boîtage	Code	Référence
110x16	Total	14	100	CHC110X16EFA2DIN6912	V600-8206494
110x25	Total	14	100	CHC110X25EFA2DIN6912	V600-8206493
110x30	Total	14	100	CHC110X30EFA2DIN6912	V600-8206492
112x40	Total	14	50	CHC112X40EFA2DIN6912	V600-8206491



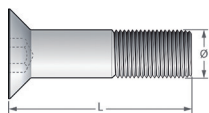

Dimensions ØxL (mm)	Filetage	Clé	Boîlage	Code	Référence
2,5X5	Total	1.5	500	FHC2,5X5EFA2	V600-8204734
2,5X6	Total	1.5	500	FHC2,5X6EFA2	V600-8204733
2,5X8	Total	1.5	500	FHC2,5X8EFA2	V600-8204732
2,5X10	Total	1.5	500	FHC2,5X10EFA2	V600-8204731
2,5X12	Total	1.5	500	FHC2,5X12EFA2	V600-8204730
3X5	Total	2	500	FHC3X5EFA2	V600-8204729
3X6	Total	2	500	FHC3X6EFA2	V600-8204728
3X8	Total	2	500	FHC3X8EFA2	V600-8204726
3X10	Total	2	500	FHC3X10EFA2	V600-8204727
3X12	Total	2	500	FHC3X12EFA2	V600-8204724
3X14	Total	2	500	FHC3X14EFA2	V600-8204725
3X16	Total	2	500	FHC3X16EFA2	V600-8204723
3X20	Total	2	500	FHC3X20EFA2	V600-8204722
3X25	Total	2	500	FHC3X25EFA2	V600-8204720
3X30	Total	2	500	FHC3X30EFA2	V600-8204721
3X40	Total	2	500	FHC3X40EFA2	V600-8204719
3x50	Total	2.5	200	FHC3X50EFA2ISO	V600-8206628
4X6	Total	2.5	500	FHC4X6EFA2	V600-8204718
4X8	Total	2.5	500	FHC4X8EFA2	V600-8204717
4X10	Total	2.5	500	FHC4X10EFA2	V600-8204716
4X12	Total	2.5	500	FHC4X12EFA2	V600-8204715
4X14	Total	2.5	500	FHC4X14EFA2	V600-8204714
4X16	Total	2.5	500	FHC4X16EFA2	V600-8204713
4X20	Total	2.5	500	FHC4X20EFA2	V600-8204712
4X25	Total	2.5	500	FHC4X25EFA2	V600-8204709
4X30	Total	2.5	500	FHC4X30EFA2	V600-8204711
4X35	Total	2.5	200	FHC4X35EFA2	V600-8204710
4X40	Total	2.5	200	FHC4X40EFA2	V600-8204708
4X50	Total	2.5	200	FHC4X50EFA2	V600-8204707
5X8	Total	3	500	FHC5X8EFA2	V600-8204706
5X10	Total	3	500	FHC5X10EFA2	V600-8204705
5X12	Total	3	500	FHC5X12EFA2	V600-8204704
5X14	Total	3	500	FHC5X14EFA2	V600-8204703
5X16	Total	3	500	FHC5X16EFA2	V600-8204701
5X20	Total	3	500	FHC5X20EFA2	V600-8204702
5X25	Total	3	200	FHC5X25EFA2	V600-8204700
5X30	Total	3	200	FHC5X30EFA2	V600-8204699
5X35	Total	3	200	FHC5X35EFA2	V600-8204698
5X40	Total	3	200	FHC5X40EFA2	V600-8204697
5X45	Total	3	200	FHC5X45EFA2	V600-8204696
5X50	Total	3	200	FHC5X50EFA2	V600-8204695
5X60	Total	3	100	FHC5X60EFA2	V600-8204693
5X70	Total	3	100	FHC5X70EFA2	V600-8204694
5X80	Total	3	100	FHC5X80EFA2	V600-8204692
6X8	Total	4	500	FHC6X8EFA2	V600-8204691
6X10	Total	4	500	FHC6X10EFA2	V600-8204690
6X12	Total	4	500	FHC6X12EFA2	V600-8204689
6X14	Total	4	200	FHC6X14EFA2	V600-8204688
6X16	Total	4	200	FHC6X16EFA2	V600-8204687
6x18	Total	4	200	FHC6X18EFA2ISO	V600-8206626
6X20	Total	4	200	FHC6X20EFA2	V600-8204686
6X25	Total	4	200	FHC6X25EFA2	V600-8204685
6X30	Total	4	200	FHC6X30EFA2	V600-8204684
6X35	Total	4	200	FHC6X35EFA2	V600-8204683
6X40	Total	4	200	FHC6X40EFA2	V600-8204682
6X45	Total	4	100	FHC6X45EFA2	V600-8204680
6X50	Total	4	100	FHC6X50EFA2	V600-8204681
6X55	Total	4	100	FHC6X55EFA2	V600-8204678
6X60	Total	4	100	FHC6X60EFA2	V600-8204679
6x60a2	Total	4	100	FHC6X60EFA2ISO	V600-8206624

Dimensions ØxL (mm)	Filetage	Clé	Boîlage	Code	Référence
6X70	Total	4	100	FHC6X70EFA2	V600-8204677
6X80	Total	4	100	FHC6X80EFA2	V600-8204676
6x90	Total	4	100	FHC6X90EFA2	V600-8206623
6x100	Total	4	100	FHC6X100EFA2	V600-8206627
8X10	Total	5	500	FHC8X10EFA2	V600-8204675
8X12	Total	5	500	FHC8X12EFA2	V600-8204673
8X16	Total	5	200	FHC8X16EFA2	V600-8204672
8X18	Total	5	200	FHC8X18EFA2	V600-8204674
8X20	Total	5	200	FHC8X20EFA2	V600-8204671
8X25	Total	5	200	FHC8X25EFA2	V600-8204670
8X30	Total	5	200	FHC8X30EFA2	V600-8204668
8X35	Total	5	100	FHC8X35EFA2	V600-8204669
8X40	Total	5	200	FHC8X40EFA2	V600-8204667
8X45	Total	8	100	FHC8X45EFA2	V600-8205169
8X50	Total	5	100	FHC8X50EFA2	V600-8204665
8X55	Total	5	100	FHC8X55EFA2	V600-8204664
8X60	Total	5	100	FHC8X60EFA2	V600-8204663
8x65	Total	5	100	FHC8X65EFA2	V600-8206619
8x70	Total	5	100	FHC8X70EFA2	V600-8206618
8X80	Total	5	100	FHC8X80EFA2	V600-8204662
8x90	Total	5	100	FHC8X90EFA2	V600-8206617
8x100	Total	5	50	FHC8X100EFA2	V600-8206622
8x110	Total	5	50	FHC8X110EFA2	V600-8206621
8x130	Total	5	50	FHC8X130EFA2	V600-8206620
10X16	Total	6	100	FHC10X16EFA2	V600-8204660
10X20	Total	6	100	FHC10X20EFA2	V600-8204661
10X25	Total	6	100	FHC10X25EFA2	V600-8204659
10X30	Total	6	100	FHC10X30EFA2	V600-8204658
10X35	Total	6	100	FHC10X35EFA2	V600-8204657
10X40	Total	6	100	FHC10X40EFA2	V600-8204656
10X45	Total	6	100	FHC10X45EFA2	V600-8204655
10X50	Total	6	50	FHC10X50EFA2	V600-8204654
10X55	Total	6	50	FHC10X55EFA2	V600-8204653
10X60	Total	6	50	FHC10X60EFA2	V600-8204652
10X70	Total	6	50	FHC10X70EFA2	V600-8204650
10x80	Total	6	50	FHC10X80EFA2	V600-8206634
10x100	Total	6	50	FHC10X100EFA2	V600-8207197
10x120	Total	6	50	FHC10X120EFA2	V600-8207196
12X20	Total	8	50	FHC12X20EFA2	V600-8204649
12X25	Total	8	50	FHC12X25EFA2	V600-8204651
12X30	Total	8	50	FHC12X30EFA2	V600-8204648
12X35	Total	8	50	FHC12X35EFA2	V600-8204647
12X40	Total	8	50	FHC12X40EFA2	V600-8204646
12X45	Total	8	50	FHC12X45EFA2	V600-8204645
12X50	Total	8	50	FHC12X50EFA2	V600-8204644
12X55	Total	8	50	FHC12X55EFA2	V600-8204643
12X60	Total	8	50	FHC12X60EFA2	V600-8204642
12x70	Total	8	50	FHC12X70EFA2	V600-8206633
12x80	Total	8	25	FHC12X80EFA2	V600-8206632
12x100	Total	8	25	FHC12X100EFA2	V600-8207195
16X25	Total	10	25	FHC16X25EFA2	V600-8204641
16x30	Total	10	25	FHC16X30EFA2ISO	V600-8206631
16x35	Total	10	25	FHC16X35EFA2ISO	V600-8206630
16X40	Total	10	25	FHC16X40EFA2	V600-8204640
16X50	Total	10	25	FHC16X50EFA2	V600-8204639
16X60	Total	10	25	FHC16X60EFA2	V600-8204637
16x80	Total	10	25	FHC16X80EFA2	V600-8206629
20X50	Total	12	25	FHC20X50EFA2	V600-8204638
20x110	Total	PZ1	25	FHC20X110EFA2	V600-8207194

Autres dimensions disponibles sur demande.

VIS POUR AGGLOMÉRÉ TÊTE FRAISÉE POZIDRIV A2

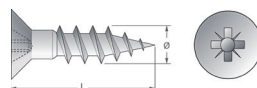

Dimensions ØxL (mm)	Filetage	Clé	Boitage	Code	Référence
3X12	Total	PZ1	500	VATF3X12POZA2	V600-8204463
3X16	Total	PZ1	500	VATF3X16POZA2	V600-8204462
3x10	Total	PZ1	500	VATF3X10POZA2	V600-8206220
3X20	Total	PZ1	500	VATF3X20POZA2	V600-8204461
3X25	Total	PZ1	500	VATF3X25POZA2	V600-8204460
3X30	Total	PZ1	500	VATF3X30POZA2	V600-8204458
3X40	Total	PZ1	200	VATF3X40POZA2	V600-8204459
3,5x20	Total	PZ2	500	VATF3,5X20POZA2	V600-8206219
3,5X25	Total	PZ2	500	VATF3,5X25POZA2	V600-8204457
3,5X35	Total	PZ2	500	VATF3,5X35POZA2	V600-8204456
3,5X40	Total	PZ2	200	VATF3,5X40POZA2	V600-8204455
4X12	Total	PZ2	500	VATF4X12POZA2	V600-8204454
4X16	Total	PZ2	500	VATF4X16POZA2	V600-8204453
4X20	Total	PZ2	500	VATF4X20POZA2	V600-8204452
4X25	Total	PZ2	500	VATF4X25POZA2	V600-8204451
4X30	Total	PZ2	500	VATF4X30POZA2	V600-8204450
4X35	Total	PZ2	500	VATF4X35POZA2	V600-8204448
4X40	Total	PZ2	500	VATF4X40POZA2	V600-8204449
4X45	Total	PZ2	200	VATF4X45POZA2	V600-8204447
4X50	Total	PZ2	500	VATF4X50POZA2	V600-8204446
4X60	Total	PZ2	200	VATF4X60TFPOZA2	V600-8204445
4x70	Total	PZ2	200	VATF4X70POZA2	V600-8206218
4x80	Total	PZ2	200	VATF4X80POZA2	V600-8206217
4,5X16	Total	PZ2	500	VATF4,5X16POZA2	V600-8204444

Dimensions ØxL (mm)	Filetage	Clé	Boitage	Code	Référence
4,5x20	Total	PZ2	500	VATF4,5X20POZA2	V600-8206216
4,5X30	Total	PZ2	500	VATF4,5X30POZA2	V600-8204443
4,5X35	Total	PZ2	500	VATF4,5X35POZA2	V600-8204441
4,5X40	Total	PZ2	200	VATF4,5X40POZA2	V600-8204442
4,5X50	Total	PZ2	200	VATF4,5X50POZA2	V600-8204440
4,5x60	Total	PZ2	200	VATF4,5X60POZA2	V600-8206215
5X20	Total	PZ2	500	VATF5X20POZA2	V600-8204439
5X25	Total	PZ2	500	VATF5X25POZA2	V600-8204438
5X30	Total	PZ2	500	VATF5X30POZA2	V600-8204437
5X35	Total	PZ2	200	VATF5X35POZA2	V600-8204436
5X40	Total	PZ2	200	VATF5X40POZA2	V600-8204434
5X45	Total	PZ2	200	VATF5X45POZA2	V600-8204435
5X50	Total	PZ2	200	VATF5X50POZA2	V600-8204433
5X60	Total	PZ2	200	VATF5X60POZA2	V600-8204432
5X70	Total	PZ2	100	VATF5X70POZA2	V600-8204431
5x80	Total	PZ2	100	VATF5X80POZA2	V600-8206214
6X30	Total	PZ3	100	VATF6X30POZA2	V600-8204429
6X35	Total	PZ3	100	VATF6X35POZA2	V600-8204430
6X40	Total	PZ3	200	VATF6X40POZA2	V600-8204428
6X50	Total	PZ3	200	VATF6X50POZA2	V600-8204427
6X60	Total	PZ3	200	VATF6X60POZA2	V600-8204426
6X70	Total	PZ3	100	VATF6X70POZA2	V600-8204425
6X80	Total	PZ3	100	VATF6X80POZA2	V600-8204423
6X100	Total	PZ3	100	VATF6X100POZA2	V600-8204424

Autres dimensions disponibles sur demande.

VIS PÔELIER TÊTE RONDE LARGE FENDUE EN CROIX A2

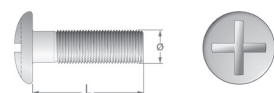

Dimensions ØxL (mm)	Boitage	Code	Référence
4X20	500	VMTRL4X20A2	V600-8204480
4X30	500	VMTRL4X30A2	V600-8204479
5X16	500	VMTRL5X16A2	V600-8204478
5X20	500	VMTRL5X20A2	V600-8204477
5X30	500	VMTRL5X30A2	V600-8204476
5X40	500	VMTRL5X40A2	V600-8204475
6X10	500	VMTRL6X10A2	V600-8204474
6X12	500	VMTRL6X12A2	V600-8204473
6X16	500	VMTRL6X16A2	V600-8204472

Dimensions ØxL (mm)	Boitage	Code	Référence
6X20	500	VMTRL6X20A2	V600-8204471
6X25	200	VMTRL6X25A2	V600-8204470
6X30	200	VMTRL6X30A2	V600-8204469
6X40	200	VMTRL6X40A2	V600-8204468
8X16	200	VMTRL8X16A2	V600-8204467
8X20	200	VMTRL8X20A2	V600-8204466
8X30	200	VMTRL8X30A2	V600-8204465
8X40	200	VMTRL8X40A2	V600-8204464

Autres dimensions disponibles sur demande.



VIS TÊTE HEXAGONALE TIREFOND A2



Dimensions ØxL (mm)	Boîlage	Code	Référence
5x40	200	TIR5X40A2	V600-8207010
5x70	200	TIR5X70A2	V600-8207009
6x25	200	TIR6X25A2	V600-8207007
6X30	200	TIR6X30A2	V600-8204604
6X40	200	TIR6X40A2	V600-8204603
6X50	200	TIR6X50A2	V600-8204602
6X60	200	TIR6X60A2	V600-8204601
6x70	100	TIR6X70A2	V600-8207006
6x100	100	TIR6X100A2	V600-8207008
8X40	100	TIR8X40A2	V600-8204600
8x45	100	TIR8X45A2	V600-8207004
8X50	100	TIR8X50A2	V600-8204599
8X60	100	TIR8X60A2	V600-8204598
8X70	100	TIR8X70A2	V600-8204597
8X80	100	TIR8X80A2	V600-8204596

Dimensions ØxL (mm)	Boîlage	Code	Référence
8X100	100	TIR8X100A2	V600-8204595
8x120	100	TIR8X120A2	V600-8207005
10x40	100	TIR10X40A2	V600-8207016
10x50	100	TIR10X50A2	V600-8207015
10X60	100	TIR10X60A2	V600-8204594
10X70	100	TIR10X70A2	V600-8204593
10x80	100	TIR10X80A2	V600-8207014
10x90	100	TIR10X90A2	V600-8207013
10X100	50	TIR10X100A2	V600-8204592
10x120	50	TIR10X120A2	V600-8207317
10x140	50	TIR10X140A2	V600-8207316
10x160	50	TIR10X160A2	V600-8207315
12x80	50	TIR12X80A2	V600-8207012
12x90	50	TIR12X90A2	V600-8207011
12x100	50	TIR12X100A2	V600-8207314



VIS À TÊTE CYLINDRIQUE FENDUE



Dimensions ØxL (mm)	Filetage	Boîlage	Code	Référence
1,6x5	Total	1000	VTCF DU1,6X5EFA2	V600-8207113
1,6x10	Total	1000	VTCF DU1,6X10EFA2	V600-8207188
1,6x12	Total	1000	VTCF DU1,6X12EFA2	V600-8207187
1,6x16	Total	1000	VTCF DU1,6X16EFA2	V600-8207186
1,6x6	Total	1000	VTCF DU1,6X6EFA2	V600-8207185
2x10	Total	1000	VTCF DU2X10EFA2	V600-8207184
2x16	Total	1000	VTCF DU2X16EFA2	V600-8207183
2x20	Total	1000	VTCF DU2X20EFA2	V600-8207182
2x3	Total	1000	VTCF DU2X3EFA2	V600-8207181
2x4	Total	1000	VTCF DU2X4EFA2	V600-8207180
2x5	Total	1000	VTCF DU2X5EFA2	V600-8207179
2x6	Total	1000	VTCF DU2X6EFA2	V600-8207178
2x8	Total	1000	VTCF DU2X8EFA2	V600-8207177
2,5x10	Total	1000	VTCF DU2,5X10EFA2	V600-8207176
2,5x12	Total	1000	VTCF DU2,5X12EFA2	V600-8207175
2,5x16	Total	1000	VTCF DU2,5X16EFA2	V600-8207174
2,5x20	Total	1000	VTCF DU2,5X20EFA2	V600-8207173
2,5x4	Total	1000	VTCF DU2,5X4EFA2	V600-8207172
2,5x6	Total	1000	VTCF DU2,5X6EFA2	V600-8207171
3x10	Total	500	VTCF DU3X10EFA2	V600-8207170
3x12	Total	500	VTCF DU3X12EFA2	V600-8207169
3x16	Total	500	VTCF DU3X16EFA2	V600-8207168
3x18	Total	500	VTCF DU3X18EFA2	V600-8207167
3x20	Total	500	VTCF DU3X20EFA2	V600-8207166
3x25	Total	500	VTCF DU3X25EFA2	V600-8207165
3x30	Total	500	VTCF DU3X30EFA2	V600-8207164
3x35	Total	500	VTCF DU3X35EFA2	V600-8207163
3x4	Total	500	VTCF DU3X4EFA2	V600-8207162
3x40	Total	500	VTCF DU3X40EFA2	V600-8207161
3x5	Total	500	VTCF DU3X5EFA2	V600-8207160
3x50	Total	500	VTCF DU3X50EFA2	V600-8207159
3x6	Total	500	VTCF DU3X6EFA2	V600-8207158
3x8	Total	500	VTCF DU3X8EFA2	V600-8207157
4x10	Total	500	VTCF DU4X10EFA2	V600-8207156
4x12	Total	500	VTCF DU4X12EFA2	V600-8207155
4x16	Total	500	VTCF DU4X16EFA2	V600-8207154
4x20	Total	500	VTCF DU4X20EFA2	V600-8207153
4x25	Total	500	VTCF DU4X25EFA2	V600-8207152
4x30	Total	500	VTCF DU4X30EFA2	V600-8207151
4x4	Total	500	VTCF DU4X4EFA2	V600-8207150
4x40	Total	500	VTCF DU4X40EFA2	V600-8207149

Dimensions ØxL (mm)	Filetage	Boîlage	Code	Référence
4x5	Total	500	VTCF DU4X5EFA2	V600-8207148
4x6	Total	500	VTCF DU4X6EFA2	V600-8207147
4x8	Total	500	VTCF DU4X8EFA2	V600-8207146
4x80	Total	200	VTCF DU4X80EFA2	V600-8207145
5x10	Total	500	VTCF DU5X10EFA2	V600-8207144
5x12	Total	500	VTCF DU5X12EFA2	V600-8207143
5x16	Total	500	VTCF DU5X16EFA2	V600-8207142
5x20	Total	500	VTCF DU5X20EFA2	V600-8207141
5x25	Total	500	VTCF DU5X25EFA2	V600-8207140
5x30	Total	500	VTCF DU5X30EFA2	V600-8207139
5x40	Total	500	VTCF DU5X40EFA2	V600-8207138
5x50	Total	200	VTCF DU5X50EFA2	V600-8207137
5x8	Total	500	VTCF DU5X8EFA2	V600-8207136
6x10	Total	500	VTCF DU6X10EFA2	V600-8207135
6x100	Total	200	VTCF DU6X100EFA2	V600-8207134
6x16	Total	500	VTCF DU6X16EFA2	V600-8207133
6x20	Total	500	VTCF DU6X20EFA2	V600-8207132
6x25	Total	500	VTCF DU6X25EFA2	V600-8207131
6x30	Total	200	VTCF DU6X30EFA2	V600-8207130
6x40	Total	200	VTCF DU6X40EFA2	V600-8207129
6x45	Total	200	VTCF DU6X45EFA2	V600-8207128
6x50	Total	200	VTCF DU6X50EFA2	V600-8207127
6x55	Total	200	VTCF DU6X55EFA2	V600-8207126
6x60	Total	200	VTCF DU6X60EFA2	V600-8207125
8x10	Total	200	VTCF DU8X10EFA2	V600-8207124
8x100	Total	100	VTCF DU8X100EFA2	V600-8207123
8x16	Total	200	VTCF DU8X16EFA2	V600-8207122
8x20	Total	200	VTCF DU8X20EFA2	V600-8207121
8x25	Total	200	VTCF DU8X25EFA2	V600-8207120
8x30	Total	200	VTCF DU8X30EFA2	V600-8207119
8x35	Total	200	VTCF DU8X35EFA2	V600-8207118
8x40	Total	200	VTCF DU8X40EFA2	V600-8207117
8x50	Total	200	VTCF DU8X50EFA2	V600-8207116
8x60	Total	100	VTCF DU8X60EFA2	V600-8207115
8x70	Total	100	VTCF DU8X70EFA2	V600-8207114
10x16	Total	100	VTCF DU10X16EFA2	V600-8207192
10x25	Total	100	VTCF DU10X25EFA2	V600-8207191
10x40	Total	100	VTCF DU10X40EFA2	V600-8207190
10x60	Total	100	VTCF DU10X60EFA2	V600-8207189
10x100	Total	50	VTCF DU10X100EFA2	V600-8207320

VIS PAPILLON



A2

Anfitec



Dimensions ØxL (mm)	Filetage	Boîtage	Code	Référence
10x16	Total	25	VISOREIL10X16A2	V600-8207033
10x30	Total	25	VISOREIL10X30A2	V600-8207032
4x12	Total	100	VISOREIL4X12A2	V600-8207031
4x16	Total	100	VISOREIL4X16A2	V600-8207030
4x20	Total	100	VISOREIL4X20A2	V600-8207029
5x12	Total	50	VISOREIL5X12A2	V600-8207028
5x35	Total	50	VISOREIL5X35A2	V600-8207027
6x10	Total	50	VISOREIL6X10A2	V600-8207026
6x16	Total	50	VISOREIL6X16A2	V600-8207025

Dimensions ØxL (mm)	Filetage	Boîtage	Code	Référence
6x20	Total	50	VISOREIL6X20A2	V600-8207024
6x40	Total	50	VISOREIL6X40A2	V600-8207023
8x16	Total	50	VISOREIL8X16A2	V600-8207022
8x20	Total	50	VISOREIL8X20A2	V600-8207021
8x30	Total	50	VISOREIL8X30A2	V600-8207020
8x35	Total	50	VISOREIL8X35A2	V600-8207019
8x40	Total	50	VISOREIL8X40A2	V600-8207018
8x50	Total	50	VISOREIL8X50A2	V600-8207017

VIS À TÊTE BOMBÉE À COLLET CARRÉ



DIN
603

A2

Anfitec



Dimensions ØxL (mm)	Filetage	Boîtage	Code	Référence
5x16	Total	25	VTRCC5X16A2EF	V600-8206992
5x35	Total	200	VTRCC5X35A2EF	V600-8206991
6x16	Total	200	VTRCC6X16A2EF	V600-8206990
6x20	Total	200	VTRCC6X20A2EF	V600-8206989
6x30	Total	200	VTRCC6X30A2EF	V600-8206988
6x35	Total	200	VTRCC6X35A2EF	V600-8206987
6x40	Total	200	VTRCC6X40A2EF	V600-8206986
6x45	Total	200	VTRCC6X45A2EF	V600-8206985
6x50	Total	100	VTRCC6X50A2EF	V600-8206984
6x55	Total	100	VTRCC6X55A2EF	V600-8206983
6x60	Total	100	VTRCC6X60A2EF	V600-8206982
6x70	Total	100	VTRCC6X70A2EF	V600-8206981
6x90	Total	100	VTRCC6X90A2EF	V600-8206980
8x120	Total	50	VTRCC8X120A2EF	V600-8206978
8x20	Total	100	VTRCC8X20A2EF	V600-8206977
8x25	Total	100	VTRCC8X25A2EF	V600-8206976
8x30	Total	100	VTRCC8X30A2EF	V600-8206975
8x35	Total	100	VTRCC8X35A2EF	V600-8206974
8x40	Total	100	VTRCC8X40A2EF	V600-8206973
8x50	Total	100	VTRCC8X50A2EF	V600-8206972
8x60	Total	100	VTRCC8X60A2EF	V600-8206971
8x70	Total	50	VTRCC8X70A2EF	V600-8206970
8x80	Total	50	VTRCC8X80A2EF	V600-8206969

Dimensions ØxL (mm)	Filetage	Boîtage	Code	Référence
10x20	Total	100	VTRCC10X20A2EF	V600-8207001
10x25	Total	100	VTRCC10X25A2EF	V600-8207000
10x30	Total	100	VTRCC10X30A2EF	V600-8206999
10x40	Total	100	VTRCC10X40A2EF	V600-8207365
10x50	Total	50	VTRCC10X50A2EF	V600-8207364
10x60	Total	50	VTRCC10X60A2EF	V600-8207363
10x65	Total	50	VTRCC10X65A2EF	V600-8207362
10x80	Total	50	VTRCC10X80A2EF	V600-8207361
10x90	Total	50	VTRCC10X90A2EF	V600-8207360
10x140	Total	50	VTRCC10X140A2EF	V600-8207003
10x150	Total	50	VTRCC10X150A2EF	V600-8207002
10x160	Total	50	VTRCC10X160A2EF	V600-8207313
12x30	Total	50	VTRCC12X30A2EF	V600-8206996
12x50	Total	50	VTRCC12X50A2EF	V600-8206995
12x60	Total	50	VTRCC12X60A2EF	V600-8207359
12x70	Total	50	VTRCC12X70A2EF	V600-8207358
12x80	Total	50	VTRCC12X80A2EF	V600-8207357
12x110	Total	50	VTRCC12X110A2EF	V600-8206998
12x140	Total	50	VTRCC12X140A2EF	V600-8206997
12x160	Total	50	VTRCC12X160A2EF	V600-8207312
16x40	Total	25	VTRCC16X40A2EF	V600-8206994
16x50	Total	25	VTRCC16X50A2EF	V600-8206993



DIN
963

Dimensions ØxL (mm)	Filetage	Boîtage	Code	Référence
1,6x4	Total	1000	VTCF DU1,6X4EFA2	V600-8206762
2,5x5	Total	1000	VTCF DU2,5X5EFA2	V600-8206752
2,5x8	Total	1000	VTCF DU2,5X8EFA2	V600-8206750
3x14	Total	500	VTCF DU3X14EFA2	V600-8206747
5x60	Total	200	VTCF DU5X60EFA2	V600-8206716
5x65	Total	200	VTCF DU5X65EFA2	V600-8206715
5x70	Total	200	VTCF DU5X70EFA2	V600-8206714
6x12	Total	500	VTCF DU6X12EFA2	V600-8206711
6x35	Total	200	VTCF DU6X35EFA2	V600-8206706
6x70	Total	200	VTCF DU6X70EFA2	V600-8206702
6x80	Total	200	VTCF DU6X80EFA2	V600-8206701
10x30	Total	100	VTCF DU10X30EFA2	V600-8206766
10x50	Total	100	VTCF DU10X50EFA2	V600-8206764
10x70	Total	50	VTCF DU10X70EFA2	V600-8206763
2x10	Total	1000	VTFF DU2X10EFA2	V600-8206761
2x16	Total	1000	VTFF DU2X16EFA2	V600-8206760
2x4	Total	1000	VTFF DU2X4EFA2	V600-8206759
2x5	Total	1000	VTFF DU2X5EFA2	V600-8206758
2x6	Total	1000	VTFF DU2X6EFA2	V600-8206757
2,5x10	Total	1000	VTFF DU2,5X10EFA2	V600-8206756
2,5x12	Total	1000	VTFF DU2,5X12EFA2	V600-8206755
2,5x16	Total	1000	VTFF DU2,5X16EFA2	V600-8206754
2,5x4	Total	1000	VTFF DU2,5X4EFA2	V600-8206753
2,5x6	Total	1000	VTFF DU2,5X6EFA2	V600-8206751
3x10	Total	500	VTFF DU3X10EFA2	V600-8206749
3x12	Total	500	VTFF DU3X12EFA2	V600-8206748
3x16	Total	500	VTFF DU3X16EFA2	V600-8206746
3x20	Total	500	VTFF DU3X20EFA2	V600-8206745
3x25	Total	500	VTFF DU3X25EFA2	V600-8206744
3x30	Total	500	VTFF DU3X30EFA2	V600-8206743
3x4	Total	500	VTFF DU3X4EFA2	V600-8206742
3x5	Total	500	VTFF DU3X5EFA2	V600-8206741
3x50	Total	200	VTFF DU3X50EFA2	V600-8206740
3x6	Total	500	VTFF DU3X6EFA2	V600-8206739
3x8	Total	500	VTFF DU3X8EFA2	V600-8206738
4x10	Total	500	VTFF DU4X10EFA2	V600-8206737
4x12	Total	500	VTFF DU4X12EFA2	V600-8206736

Dimensions ØxL (mm)	Filetage	Boîtage	Code	Référence
4x16	Total	500	VTFF DU4X16EFA2	V600-8206735
4x20	Total	500	VTFF DU4X20EFA2	V600-8206734
4x25	Total	500	VTFF DU4X25EFA2	V600-8206733
4x30	Total	500	VTFF DU4X30EFA2	V600-8206732
4x40	Total	500	VTFF DU4X40EFA2	V600-8206731
4x45	Total	500	VTCF DU4X45EFA2	V600-8206730
4x50	Total	500	VTCF DU4X50EFA2	V600-8206729
4x55	Total	500	VTCF DU4X55EFA2	V600-8206728
4x6	Total	500	VTFF DU4X6EFA2	V600-8206727
4x8	Total	500	VTFF DU4X8EFA2	V600-8206725
5x10	Total	500	VTFF DU5X10EFA2	V600-8206724
5x12	Total	500	VTFF DU5X12EFA2	V600-8206723
5x16	Total	500	VTFF DU5X16EFA2	V600-8206722
5x20	Total	500	VTFF DU5X20EFA2	V600-8206721
5x25	Total	500	VTFF DU5X25EFA2	V600-8206720
5x30	Total	500	VTFF DU5X30EFA2	V600-8206719
5x40	Total	500	VTFF DU5X40EFA2	V600-8206718
5x50	Total	200	VTFF DU5X50EFA2	V600-8206717
5x8	Total	500	VTFF DU5X8EFA2	V600-8206713
6x10	Total	500	VTFF DU6X10EFA2	V600-8206712
6x16	Total	500	VTFF DU6X16EFA2	V600-8206710
6x20	Total	200	VTFF DU6X20EFA2	V600-8206709
6x25	Total	200	VTFF DU6X25EFA2	V600-8206708
6x30	Total	200	VTFF DU6X30EFA2	V600-8206707
6x40	Total	200	VTFF DU6X40EFA2	V600-8206705
6x50	Total	200	VTFF DU6X50EFA2	V600-8206704
6x60	Total	200	VTFF DU6X60EFA2	V600-8206703
8x10	Total	200	VTFF DU8X10EFA2	V600-8206700
8x25	Total	200	VTFF DU8X25EFA2	V600-8206699
8x30	Total	200	VTFF DU8X30EFA2	V600-8206698
8x35	Total	200	VTFF DU8X35EFA2	V600-8206697
8x40	Total	200	VTFF DU8X40EFA2	V600-8206696
8x50	Total	200	VTFF DU8X50EFA2	V600-8206695
8x60	Total	100	VTFF DU8X60EFA2	V600-8206694
10x25	Total	100	VTFF DU10X25EFA2	V600-8206767
10x40	Total	100	VTFF DU10X40EFA2	V600-8206765

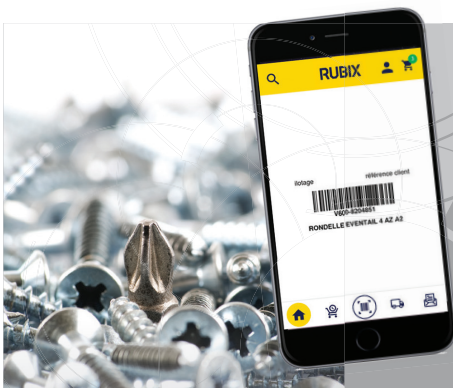

X Scannez et commandez !

Facilitez votre réassort en utilisant notre solution de scan ou notre application mobile Rubix.

VIS POELIER TLR FENDUE A2



NFE
25-129



Dimensions ØxL (mm)	Filetage	Boîtage	Code	Référence
4x10	Total	500	VMTRL4X10A2	V600-8206613
4x12	Total	500	VMTRL4X12A2	V600-8206612
4x16	Total	500	VMTRL4X16A2	V600-8206611
4x25	Total	500	VMTRL4X25A2	V600-8206610
4x40	Total	500	VMTRL4X40A2	V600-8206609
4x50	Total	500	VMTRL4X50A2	V600-8206608
4x8	Total	500	VMTRL4X8A2	V600-8206607
5x10	Total	500	VMTRL5X10A2	V600-8206606
5x12	Total	500	VMTRL5X12A2	V600-8206605
5x25	Total	500	VMTRL5X25A2	V600-8206604
5x50	Total	500	VMTRL5X50A2	V600-8206603
5x60	Total	500	VMTRL5X60A2	V600-8206602
6x35	Total	200	VMTRL6X35A2	V600-8206601
6x45	Total	200	VMTRL6X45A2	V600-8206600
6x50	Total	200	VMTRL6X50A2	V600-8206599
6x60	Total	200	VMTRL6X60A2	V600-8206598

Dimensions ØxL (mm)	Filetage	Boîtage	Code	Référence
6x70	Total	200	VMTRL6X70A2	V600-8206597
8x25	Total	200	VMTRL8X25A2	V600-8206596
8x35	Total	200	VMTRL8X35A2	V600-8206595
8x45	Total	200	VMTRL8X45A2	V600-8206594
8x50	Total	200	VMTRL8X50A2	V600-8206593
8x60	Total	100	VMTRL8X60A2	V600-8206592
8x80	Total	100	VMTRL8X80A2	V600-8206591
3x10	Total	1000	VMTRL3X10A2	V600-8206562
3x16	Total	1000	VMTRL3X16A2	V600-8206561
3x6	Total	1000	VMTRL3X6A2	V600-8206560
4x60	Total	500	VMTRL4X60A2	V600-8206559
5x70	Total	500	VMTRL5X70A2	V600-8206558
6x100	Total	200	VMTRL6X100A2	V600-8206557
8x70	Total	100	VMTRL8X70A2	V600-8209230
8x100	Total	100	VMTRL8X100A2	V600-8206556

VIS SANS TÊTE À SIX PANS CREUX BOUT PLAT



DIN
913

ISO
4026



Dimensions ØxL (mm)	Filetage	Boîtage	Code	Référence
2x10	Total	500	STHCLEFA2X10EFA2	V600-8206542
2x12	Total	500	STHCLEFA2X12EFA2	V600-8206541
2x3	Total	500	STHCLEFA2X3EFA2	V600-8206540
2x6	Total	500	STHCLEFA2X6EFA2	V600-8206539
2,5x12	Total	500	STHCLEFA2,5X12EFA2	V600-8206538
2,5x6	Total	500	STHCLEFA2,5X6EFA2	V600-8206537
3x16	Total	500	STHCPLA3X16EFA2	V600-8206536
3x20	Total	500	STHCPLA3X20EFA2	V600-8206535
3x25	Total	500	STHCPLA3X25EFA2	V600-8206534
3x5	Total	500	STHCPLA3X5EFA2	V600-8206533
3x8	Total	500	STHCPLA3X8EFA2	V600-8206532
4x25	Total	500	STHCPLA4X25EFA2	V600-8206531
4x3	Total	500	STHCPLA4X3EFA2	V600-8206530
4x30	Total	200	STHCPLA4X30EFA2	V600-8206529
4x35	Total	200	STHCPLA4X35EFA2	V600-8206528
4x4	Total	500	STHCPLA4X4EFA2	V600-8206527
5x16	Total	500	STHCPLA5X16EFA2	V600-8206526
5x20	Total	500	STHCPLA5X20EFA2	V600-8206525
5x30	Total	200	STHCPLA5X30EFA2	V600-8206524
5x35	Total	200	STHCPLA5X35EFA2	V600-8206523
5x40	Total	200	STHCPLA5X40EFA2	V600-8206522
5x50	Total	200	STHCPLA5X50EFA2	V600-8206521
6x30	Total	200	STHCPLA6X30EFA2	V600-8206520
6x45	Total	200	STHCPLA6X45EFA2	V600-8206519
6x50	Total	200	STHCPLA6X50EFA2	V600-8206518

Dimensions ØxL (mm)	Filetage	Boîtage	Code	Référence
6x6	Total	200	STHCPLA6X6EFA2	V600-8206517
8x16	Total	200	STHCPLA8X16EFA2	V600-8206516
8x25	Total	200	STHCPLA8X25EFA2	V600-8206515
8x30	Total	200	STHCPLA8X30EFA2	V600-8206514
8x35	Total	200	STHCPLA8X35EFA2	V600-8206513
8x40	Total	200	STHCPLA8X40EFA2	V600-8206512
8x45	Total	200	STHCPLA8X45EFA2	V600-8206511
8x50	Total	200	STHCPLA8X50EFA2	V600-8206510
8x6	Total	200	STHCPLA8X6EFA2	V600-8206509
8x60	Total	200	STHCPLA8X60EFA2	V600-8206508
8x70	Total	200	STHCPLA8X70EFA2	V600-8206507
10x10	Total	200	STHCPLA10X10EFA2	V600-8206555
10x16	Total	200	STHCPLA10X16EFA2	V600-8206554
10x25	Total	100	STHCPLA10X25EFA2	V600-8206553
10x30	Total	100	STHCPLA10X30EFA2	V600-8206552
10x40	Total	100	STHCPLA10X40EFA2	V600-8206551
10x45	Total	100	STHCPLA10X45EFA2	V600-8206550
10x70	Total	100	STHCPLA10X70EFA2	V600-8206549
12x12	Total	100	STHCPLA12X12EFA2	V600-8206548
12x16	Total	100	STHCPLA12X16EFA2	V600-8206547
12x20	Total	100	STHCPLA12X20EFA2	V600-8206546
12x30	Total	100	STHCPLA12X30EFA2	V600-8206545
12x40	Total	100	STHCPLA12X40EFA2	V600-8206544
12x70	Total	50	STHCPLA12X70EFA2	V600-8206543

VIS SANS TÊTE À SIX PANS CREUX À POINTE



DIN 914

ISO 4027

Dimensions ØxL (mm)	Filetage	Boîtage	Code	Référence
4x10	Total	500	STHC4X10BTPNTOA2	V600-8206506
4x16	Total	500	STHC4X16BTPNTOA2	V600-8206505
5x10	Total	500	STHC5X10BTPNTOA2	V600-8206504
5x16	Total	500	STHC5X16BTPNTOA2	V600-8206503
6x10	Total	200	STHC6X10BTPNTOA2	V600-8206502
6x16	Total	200	STHC6X16BTPNTOA2	V600-8206501

Dimensions ØxL (mm)	Filetage	Boîtage	Code	Référence
6x20	Total	200	STHC6X20BTPNTOA2	V600-8206500
6x30	Total	200	STHC6X30BTPNTOA2	V600-8206499
6x8	Total	200	STHC8X10BTPNTOA2	V600-8206498
8x10	Total	200	STHC8X16BTPNTOA2	V600-8206497
8x20	Total	200	STHC8X20BTPNTOA2	V600-8206496
6x40	Total	200	STHCPLA6X40EFA2	V600-8206495

VIS AUTOPERCEUSE À TÊTE FRAISÉE - FORME O

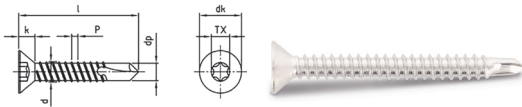

DIN 75040Z

Dimensions ØxL (mm)	Filetage	Boîtage	Code	Référence
3,5X16	Total	1000	VTFATP3,5X16EFPOZA2	V600-8206473
3,5x25	Total	1000	VTFATP3,5X25EFPOZA2	V600-8206472
3,9x19	Total	1000	VTFATP3,9X19EFPOZA2	V600-8206471
3,9x32	Total	1000	VTFATP3,9X32EFPOZA2	V600-8206470
3,9x38	Total	1000	VTFATP3,9X38EFPOZA2	V600-8206469
4,2x13	Total	1000	VTFATP4,2X13EFPOZA2	V600-8206468
4,2x16	Total	1000	VTFATP4,2X16EFPOZA2	V600-8206467
4,2x19	Total	1000	VTFATP4,2X19EFPOZA2	V600-8206466
4,2x25	Total	1000	VTFATP4,2X25EFPOZA2	V600-8206465
4,2x32	Total	1000	VTFATP4,2X32EFPOZA2	V600-8206464
4,2x38	Total	1000	VTFATP4,2X38EFPOZA2	V600-8206463

Dimensions ØxL (mm)	Filetage	Boîtage	Code	Référence
4,8x19	Total	1000	VTFATP4,8X19EFPOZA2	V600-8206462
4,8x25	Total	1000	VTFATP4,8X25EFPOZA2	V600-8206461
4,8x32	Total	1000	VTFATP4,8X32EFPOZA2	V600-8206460
4,8x45	Total	1000	VTFATP4,8X45EFPOZA2	V600-8206459
3,9x19	Total	1000	VPTF3,9X19EFA2	V600-8206458
4,2x19	Total	1000	VPTF4,2X19EFA2	V600-8206457
4,2x38	Total	1000	VPTF4,2X38EFA2	V600-8206456
4,8x25	Total	500	VPTF4,8X25EFA2	V600-8206455
4,8x38	Total	500	VPTF4,8X38EFA2	V600-8206454
4,8x45	Total	500	VPTF4,8X45EFA2	V600-8206453
4,8x50	Total	500	VPTF4,8X50EFA2	V600-8206452

Habillez votre magasin avec tout l'équipement GISS spécial visserie !



➤ Rayonnage à tablettes tôlées



➤ Bacs à bec

! Pour un devis, contactez votre agence.

VIS À TÔLE À TÊTE TCB À EMPREINTE PZ



Dimensions ØxL (mm)	Filetage	Boîtage	Code	Référence
2,9X13	Total	1000	VTCLPOZ2,9X13EFA2	V600-8206451
2,9X16	Total	1000	VTCLPOZ2,9X16EFA2	V600-8206450
2,9X19	Total	1000	VTCLPOZ2,9X19EFA2	V600-8206449
2,9X10	Total	1000	VTCLPOZ2,9X10EFA2	V600-8206448
3,5X13	Total	1000	VTCLPOZ3,5X13EFA2	V600-8206447
3,5X16	Total	1000	VTCLPOZ3,5X16EFA2	V600-8206446
3,5X19	Total	1000	VTCLPOZ3,5X19EFA2	V600-8206445
3,5X32	Total	1000	VTCLPOZ3,5X32EFA2	V600-8206444
3,5X38	Total	1000	VTCLPOZ3,5X38EFA2	V600-8206443
3,5X6,4	Total	1000	VTCLPOZ3,5X6,4EFA2	V600-8206442
3,5X10	Total	1000	VTCLPOZ3,5X10EFA2	V600-8206441
3,9X13	Total	1000	VTCLPOZ3,9X13EFA2	V600-8206440
3,9X16	Total	1000	VTCLPOZ3,9X16EFA2	V600-8206439
3,9X19	Total	1000	VTCLPOZ3,9X19EFA2	V600-8206438
3,9X25	Total	1000	VTCLPOZ3,9X25EFA2	V600-8206437
3,9X32	Total	1000	VTCLPOZ3,9X32EFA2	V600-8206436
3,9X38	Total	500	VTCLPOZ3,9X38EFA2	V600-8206435
3,9X10	Total	1000	VTCLPOZ3,9X10EFA2	V600-8206434
4,2X13	Total	1000	VTCLPOZ4,2X13EFA2	V600-8206433
4,2X16	Total	1000	VTCLPOZ4,2X16EFA2	V600-8206432
4,2X19	Total	1000	VTCLPOZ4,2X19EFA2	V600-8206431
4,2X25	Total	1000	VTCLPOZ4,2X25EFA2	V600-8206430
4,2X32	Total	500	VTCLPOZ4,2X32EFA2	V600-8206429
4,2X50	Total	200	VTCLPOZ4,2X50EFA2	V600-8206428
4,2X60	Total	200	VTCLPOZ4,2X60EFA2	V600-8206427
4,2X10	Total	1000	VTCLPOZ4,2X10EFA2	V600-8206426
4,8X13	Total	1000	VTCLPOZ4,8X13EFA2	V600-8206425

Dimensions ØxL (mm)	Filetage	Boîtage	Code	Référence
4,8X16	Total	1000	VTCLPOZ4,8X16EFA2	V600-8206424
4,8X19	Total	1000	VTCLPOZ4,8X19EFA2	V600-8206423
4,8X22	Total	1000	VTCLPOZ4,8X22EFA2	V600-8206422
4,8X25	Total	500	VTCLPOZ4,8X25EFA2	V600-8206421
4,8X32	Total	500	VTCLPOZ4,8X32EFA2	V600-8206420
4,8X38	Total	500	VTCLPOZ4,8X38EFA2	V600-8206419
4,8X45	Total	200	VTCLPOZ4,8X45EFA2	V600-8206418
4,8X50	Total	200	VTCLPOZ4,8X50EFA2	V600-8206417
4,8X60	Total	200	VTCLPOZ4,8X60EFA2	V600-8206416
4,8X70	Total	200	VTCLPOZ4,8X70EFA2	V600-8206415
4,8X80	Total	200	VTCLPOZ4,8X80EFA2	V600-8206414
4,8x100	Total	200	VTCLPOZ4,8X100EFA2	V600-8207193
5,5X13	Total	1000	VTCLPOZ5,5X13EFA2	V600-8206413
5,5X16	Total	1000	VTCLPOZ5,5X16EFA2	V600-8206412
5,5X19	Total	1000	VTCLPOZ5,5X19EFA2	V600-8206411
5,5X25	Total	500	VTCLPOZ5,5X25EFA2	V600-8206410
5,5X32	Total	500	VTCLPOZ5,5X32EFA2	V600-8206409
5,5X38	Total	500	VTCLPOZ5,5X38EFA2	V600-8206408
5,5X50	Total	200	VTCLPOZ5,5X50EFA2	V600-8206407
6,3X13	Total	500	VTCLPOZ6,3X13EFA2	V600-8206406
6,3X19	Total	500	VTCLPOZ6,3X19EFA2	V600-8206405
6,3X25	Total	200	VTCLPOZ6,3X25EFA2	V600-8206404
6,3X32	Total	200	VTCLPOZ6,3X32EFA2	V600-8206403
6,3X38 F	Total	200	VTCLPOZ6,3X38EFA2	V600-8206402
6,3X45	Total	200	VTCLPOZ6,3X45EFA2	V600-8206401
6,3X80	Total	200	VTCLPOZ6,3X80EFA2	V600-8206400

VIS À TÔLE TCB À EMPREINTE CARRÉ



Dimensions ØxL (mm)	Filetage	Boîtage	Code	Référence
3,5X19	Total	200	VCARR3,5X19EFA2	V600-8206399
4,2X13	Total	200	VCARR4,2X13EFA2	V600-8206398
4,2X22	Total	200	VCARR4,2X22EFA2	V600-8206397
4,2X45	Total	200	VCARR4,2X45EFA2	V600-8206396
4,8X16	Total	200	VCARR4,8X16EFA2	V600-8206395



Dimensions ØxL (mm)	Filetage	Boîtage	Code	Référence
2x10	Total	1000	VTFFPOZ2X10A2	V600-8206691
2x20	Total	1000	VTFFPOZ2X20A2	V600-8206690
2x4	Total	1000	VTFFPOZ2X4A2	V600-8206689
2,5x4	Total	1000	VTFFPOZ2,5X4A2	V600-8206688
2,5x8	Total	1000	VTFFPOZ2,5X8EFA2	V600-8206639
2,9X10	Total	1000	VTFFBPOZ2,9X10A2	V600-8206359
2,9X16	Total	1000	VTFFPOZ2,9X16A2	V600-8206394
2,9X19	Total	1000	VTFFPOZ2,9X19A2	V600-8206393
3x10	Total	500	VTFFPOZ3X10A2	V600-8206687
3x12	Total	500	VTFFPOZ3X12A2	V600-8206686
3x16	Total	500	VTFFPOZ3X16A2	V600-8206685
3x20	Total	500	VTFFPOZ3X20A2	V600-8206684
3x25	Total	500	VTFFPOZ3X25A2	V600-8206683
3x30	Total	500	VTFFPOZ3X30A2	V600-8206682
3x35	Total	500	VTFFPOZ3X35A2	V600-8206681
3x4	Total	500	VTFFPOZ3X4A2	V600-8206680
3x6	Total	500	VTFFPOZ3X6A2	V600-8206679
3x8	Total	500	VTFFPOZ3X8A2	V600-8206678
3,5X10	Total	1000	VTFFPOZ3,5X10A2	V600-8206388
3,5X13	Total	1000	VTFFPOZ3,5X13A2	V600-8206392
3,5X16	Total	1000	VTFFPOZ3,5X16A2	V600-8206391
3,5X19	Total	1000	VTFFPOZ3,5X19A2	V600-8206390
3,5X32	Total	1000	VTFFPOZ3,5X32A2	V600-8206389
3,9X13	Total	1000	VTFFPOZ3,9X13A2	V600-8206387
3,9X16	Total	1000	VTFFPOZ3,9X16A2	V600-8206386
3,9X19	Total	1000	VTFFPOZ3,9X19A2	V600-8206385
3,9X25	Total	1000	VTFFPOZ3,9X25A2	V600-8206384
3,9X32	Total	1000	VTFFPOZ3,9X32A2	V600-8206383
4x10	Total	500	VTFFPOZ4X10A2	V600-8206677
4x12	Total	500	VTFFPOZ4X12A2	V600-8206676
4x14	Total	500	VTFFPOZ4X14A2	V600-8206675
4x16	Total	500	VTFFPOZ4X16A2	V600-8206674
4x20	Total	500	VTFFPOZ4X20A2	V600-8206673
4x25	Total	500	VTFFPOZ4X25A2	V600-8206672
4x30	Total	500	VTFFPOZ4X30A2	V600-8206671
4x40	Total	500	VTFFPOZ4X40A2	V600-8206670
4x45	Total	500	VTFFPOZ4X45A2	V600-8206669
4x6	Total	500	VTFFPOZ4X6A2	V600-8206668
4x60	Total	500	VTFFPOZ4X60A2	V600-8206667
4x8	Total	500	VTFFPOZ4X8A2	V600-8206666
4,2X13	Total	1000	VTFFPOZ4,2X13A2	V600-8206382
4,2X16	Total	1000	VTFFPOZ4,2X16A2	V600-8206381
4,2X25	Total	1000	VTFFPOZ4,2X25A2	V600-8206380
4,2X32	Total	500	VTFFPOZ4,2X32A2	V600-8206379
4,2X45	Total	500	VTFFPOZ4,2X45A2	V600-8206378

Dimensions ØxL (mm)	Filetage	Boîtage	Code	Référence
4,2X50	Total	200	VTFFPOZ4,2X50A2	V600-8206377
4,2X10	Total	1000	VTFFPOZ4,2X10A2	V600-8206376
4,8X16	Total	1000	VTFFPOZ4,8X16A2	V600-8206375
4,8X19	Total	1000	VTFFPOZ4,8X19A2	V600-8206374
4,8X22	Total	1000	VTFFPOZ4,8X22A2	V600-8206373
4,8X25	Total	500	VTFFPOZ4,8X25A2	V600-8206372
4,8X32	Total	500	VTFFPOZ4,8X32A2	V600-8206371
4,8X45	Total	200	VTFFPOZ4,8X45A2	V600-8206370
4,8X50	Total	200	VTFFPOZ4,8X50A2	V600-8206369
4,8X60	Total	200	VTFFPOZ4,8X60A2	V600-8206368
4,8X70	Total	200	VTFFPOZ4,8X70A2	V600-8206367
5x10	Total	500	VTFFPOZ5X10A2	V600-8206665
5x12	Total	500	VTFFPOZ5X12A2	V600-8206664
5x16	Total	500	VTFFPOZ5X16A2	V600-8206663
5x20	Total	500	VTFFPOZ5X20A2	V600-8206662
5x25	Total	500	VTFFPOZ5X25A2	V600-8206661
5x30	Total	500	VTFFPOZ5X30A2	V600-8206660
5x35	Total	500	VTFFPOZ5X35A2	V600-8206659
5x40	Total	500	VTFFPOZ5X40A2	V600-8206658
5x45	Total	200	VTFFPOZ5X45A2	V600-8206657
5x50	Total	200	VTFFPOZ5X50A2	V600-8206656
5x70	Total	200	VTFFPOZ5X70A2	V600-8206655
5,5X16	Total	1000	VTFFPOZ5,5X16A2	V600-8206366
5,5X25	Total	1000	VTFFPOZ5,5X25A2	V600-8206365
5,5X38	Total	500	VTFFPOZ5,5X38A2	V600-8206364
6x10	Total	500	VTFFPOZ6X10A2	V600-8206654
6x12	Total	500	VTFFPOZ6X12A2	V600-8206653
6x16	Total	500	VTFFPOZ6X16A2	V600-8206652
6x20	Total	500	VTFFPOZ6X20A2	V600-8206651
6x25	Total	200	VTFFPOZ6X25A2	V600-8206650
6x30	Total	200	VTFFPOZ6X30A2	V600-8206649
6x35	Total	200	VTFFPOZ6X35A2	V600-8206648
6x40	Total	200	VTFFPOZ6X40A2	V600-8206647
6x45	Total	200	VTFFPOZ6X45A2	V600-8206646
6x50	Total	200	VTFFPOZ6X50A2	V600-8206645
6x80	Total	200	VTFFPOZ6X80A2	V600-8206644
6,3X19	Total	500	VTFFPOZ6,3X19A2	V600-8206363
6,3X32	Total	200	VTFFPOZ6,3X32A2	V600-8206362
6,3X38	Total	200	VTFFPOZ6,3X38A2	V600-8206361
6,3X50	Total	200	VTFFPOZ6,3X50A2	V600-8206360
8x40	Total	200	VTFFPOZ8X40A2	V600-8206643
3,9X38	Total	500	VTFFBPOZ3,9X38A2	V600-8206356
4,2X16	Total	1000	VTFFBPOZ4,2X16A2	V600-8206355
4,2X50	Total	200	VTFFBPOZ4,2X50A2	V600-8206354
4,8X38	Total	500	VTFFBPOZ4,8X38A2	V600-8206353

VIS À TÊTE BOMBÉE À EMPREINTE CRUCIFORME



DIN
7985

ISO
2466



Dimensions ØxL (mm)	Filetage	Boîlage	Code	Référence
2x16	Total	1000	VTCPOZ2X16A2	V600-8206351
2x6	Total	1000	VTCPOZ2X6A2	V600-8206350
2,5x4	Total	1000	VTCPOZ2,5X4A2	V600-8206349
3x16	Total	500	VTCPOZ3X16A2	V600-8206346
3x20	Total	500	VTCPOZ3X20A2	V600-8206345
3x25	Total	500	VTCPOZ3X25A2	V600-8206344
3x30	Total	500	VTCPOZ3X30A2	V600-8206343
3x4	Total	500	VTCPOZ3X4A2	V600-8206342
3x40	Total	500	VTCPOZ3X40A2	V600-8206341
3x5	Total	500	VTCPOZ3X5A2	V600-8206340
3x8	Total	500	VTCPOZ3X8A2	V600-8206338
4x10	Total	500	VTCPOZ4X10A2	V600-8206337
4x12	Total	500	VTCPOZ4X12A2	V600-8206336
4x16	Total	500	VTCPOZ4X16A2	V600-8206335
4x30	Total	500	VTCPOZ4X30A2	V600-8206333
4x35	Total	500	VTCPOZ4X35A2	V600-8206332
4x40	Total	500	VTCPOZ4X40A2	V600-8206331

Dimensions ØxL (mm)	Filetage	Boîlage	Code	Référence
4x50	Total	500	VTCPOZ4X50A2	V600-8206330
4x60	Total	200	VTCPOZ4X60A2	V600-8206329
4x8	Total	500	VTCPOZ4X8A2	V600-8206328
5x12	Total	500	VTCPOZ5X12A2	V600-8206326
5x16	Total	500	VTCPOZ5X16A2	V600-8206325
5x20	Total	500	VTCPOZ5X20A2	V600-8206324
5x30	Total	500	VTCPOZ5X30A2	V600-8206322
5x35	Total	500	VTCPOZ5X35A2	V600-8206321
5x40	Total	500	VTCPOZ5X40A2	V600-8206320
5x60	Total	200	VTCPOZ5X60A2	V600-8206319
6x20	Total	500	VTCPOZ6X20A2	V600-8206318
6x40	Total	200	VTCPOZ6X40A2	V600-8206317
6x50	Total	200	VTCPOZ6X50A2	V600-8206316
6x8	Total	500	VTCPOZ6X8A2	V600-8206315
8x16	Total	200	VTCPOZ8X16A2	V600-8206314
8x20	Total	200	VTCPOZ8X20A2	V600-8206313
8x40	Total	200	VTCPOZ8X40A2	V600-8206312

VIS À TÊTE BOMBÉE À SIX PANS CREUX



DIN
7981

ISO
7380



Dimensions ØxL (mm)	Filetage	Boîlage	Code	Référence
4x10	Total	1000	VTCBP4X10EFA2	V600-8209233
5x50	Total	200	VTCBP5X50EFA2	V600-8209232

VIS À TÊTE BOMBÉE FENDUE



DIN
85



Dimensions ØxL (mm)	Filetage	Boîlage	Code	Référence
5x30	Total	500	VMTCL5X30EFA2	V600-8209231

VIS POUR AGGLOMÉRÉ À TÊTE RONDE RENFORCÉE



Dimensions ØxL (mm)	Filetage	Boîlage	Code	Référence
3x12	Total	500	VATC3X12EFPOZA2	V600-8206243
3x16	Total	500	VATC3X16EFPOZA2	V600-8206242
3,5x25	Total	500	VATC3,5X25EFPOZA2	V600-8206241
4x13	Total	500	VATC4X13EFPOZA2	V600-8206240
4x16	Total	500	VATC4X16EFPOZA2	V600-8206239
4x20	Total	500	VATC4X20EFPOZA2	V600-8206238
4x25	Total	500	VATC4X25EFPOZA2	V600-8206237
4x30	Total	500	VATC4X30EFPOZA2	V600-8206236
4x35	Total	500	VATC4X35EFPOZA2	V600-8206235
4x40	Total	200	VATC4X40EFPOZA2	V600-8206234
4,5x16	Total	500	VATC4,5X16EFPOZA2	V600-8206233
4,5x25	Total	500	VATC4,5X25EFPOZA2	V600-8206232

Dimensions ØxL (mm)	Filetage	Boîlage	Code	Référence
4,5x35	Total	500	VATC4,5X35EFPOZA2	V600-8206231
4,5x40	Total	500	VATC4,5X40EFPOZA2	V600-8206230
5x20	Total	500	VATC5X20EFPOZA2	V600-8206229
5x25	Total	500	VATC5X25EFPOZA2	V600-8206228
5x40	Total	200	VATC5X40EFPOZA2	V600-8206227
5x50	Total	200	VATC5X50EFPOZA2	V600-8206226
5x60	Total	100	VATC5X60EFPOZA2	V600-8206225
5x80	Total	100	VATC5X80EFPOZA2	V600-8206224
6x30	Total	100	VATC6X30EFPOZA2	V600-8206223
6x50	Total	100	VATC6X50EFPOZA2	V600-8206222
6x60	Total	100	VATC6X60EFPOZA2	V600-8206221



GOUPILLE ÉLASTIQUE FENDUE ET MASSIVE



ISO
8752

Dimensions ØxL (mm)	Boîtage	Code	Référence
1X12	1000	GOELAS1X12A1	V600-8206310
1X5	1000	GOELAS1X5A1	V600-8206309
1X8	1000	GOELAS1X8A1	V600-8206308
1,5X5	1000	GOELAS1,5X5A1	V600-8206299
1,5X6	1000	GOELAS1,5X6A1	V600-8206298
1,5X10	1000	GOELAS1,5X10A1	V600-8206304
1,5X12	1000	GOELAS1,5X12A1	V600-8206303
1,5X14	1000	GOELAS1,5X14A1	V600-8206302
1,5X16	1000	GOELAS1,5X16A1	V600-8206301
1,5X18	1000	GOELAS1,5X18A1	V600-8206300
2X5	1000	GOELAS2X5A1	V600-8206292
2X8	1000	GOELAS2X8A1	V600-8206291
2X10	1000	GOELAS2X10A1	V600-8206297
2X12	1000	GOELAS2X12A1	V600-8206296
2X16	1000	GOELAS2X16A1	V600-8206295
2X20	1000	GOELAS2X20A1	V600-8206294
2X30	1000	GOELAS2X30A1	V600-8206293
2,5X16	1000	GOELAS2,5X16A1	V600-8206290
2,5X18	1000	GOELAS2,5X18A1	V600-8206289
2,5X20	1000	GOELAS2,5X20A1	V600-8206288
2,5X6	1000	GOELAS2,5X6A1	V600-8206287
3X6	1000	GOELAS3X6A1	V600-8206278
3X8	1000	GOELAS3X8A1	V600-8206277
3X10	1000	GOELAS3X10A1	V600-8206286
3X12	1000	GOELAS3X12A1	V600-8206285
3X16	1000	GOELAS3X16A1	V600-8206284
3X18	1000	GOELAS3X18A1	V600-8206283
3X20	1000	GOELAS3X20A1	V600-8206282
3X30	1000	GOELAS3X30A1	V600-8206280
3X40	1000	GOELAS3X40A1	V600-8206279
3,5X20	1000	GOELAS3,5X20A1	V600-8206276
3,5X30	1000	GOELAS3,5X30A1	V600-8206275
4X10	500	GOELAS4X10A1	V600-8206274

Dimensions ØxL (mm)	Boîtage	Code	Référence
4X12	500	GOELAS4X12A1	V600-8206273
4X14	500	GOELAS4X14A1	V600-8206272
4X16	500	GOELAS4X16A1	V600-8206271
4X20	500	GOELAS4X20A1	V600-8206270
4X30	500	GOELAS4X30A1	V600-8206269
4X40	500	GOELAS4X40A1	V600-8206268
4X45	500	GOELAS4X45A1	V600-8206267
4X50	500	GOELAS4X50A1	V600-8206266
5X8	500	GOELAS5X8A1	V600-8206258
5X10	500	GOELAS5X10A1	V600-8206265
5X30	500	GOELAS5X30A1	V600-8206263
5X40	500	GOELAS5X40A1	V600-8206262
5X50	250	GOELAS5X50A1	V600-8206261
5X60	250	GOELAS5X60A1	V600-8206260
5X70	250	GOELAS5X70A1	V600-8206259
6X16	500	GOELAS6X16A1	V600-8206257
6X20	500	GOELAS6X20A1	V600-8206256
6X30	500	GOELAS6X30A1	V600-8206255
6X40	250	GOELAS6X40A1	V600-8206254
6X50	250	GOELAS6X50A1	V600-8206253
6X60	250	GOELAS6X60A1	V600-8206252
6X80	250	GOELAS6X80A1	V600-8206251
8X18	500	GOELAS8X18A1	V600-8206249
8X30	250	GOELAS8X30A1	V600-8206248
8X40	250	GOELAS8X40A1	V600-8206247
8X50	250	GOELAS8X50A1	V600-8206246
8X60	250	GOELAS8X60A1	V600-8206245
8X80	250	GOELAS8X80A1	V600-8206244
8X100	100	GOELAS8X100A1	V600-8206250
10X60	200	GOELAS10X60A1	V600-8206307
10X70	100	GOELAS10X70A1	V600-8206306
10X80	100	GOELAS10X80A1	V600-8206305



GOUPILLE CYLINDRIQUE FENDUE A2



DIN
94

ISO
1234

Dimensions ØxL (mm)	Boîtage	Code	Référence
1,2X40	1000	GOFDU1,2X40A2	V600-8207112
1,6X12	1000	GOFDU1,6X12A2	V600-8207111
2,5X16	1000	GOFDU2,5X16A2	V600-8207110
2,5X20	1000	GOFDU2,5X20A2	V600-8207109
3,2X20	500	GOFDU3,2X20A2	V600-8207108
3,2X32	500	GOFDU3,2X32A2	V600-8207107
3,2X45	500	GOFDU3,2X45A2	V600-8207106

Dimensions ØxL (mm)	Boîtage	Code	Référence
3,2X63	500	GOFDU3,2X63A2	V600-8207105
4X25	500	GOFDU4X25A2	V600-8207104
4X45	500	GOFDU4X45A2	V600-8207103
5X40	250	GOFDU5X40A2	V600-8207102
5X50	250	GOFDU5X50A2	V600-8207101
6,3X63	250	GOFDU6,3X63A2	V600-8207100

CIRCLIPS® INTÉRIEUR A2

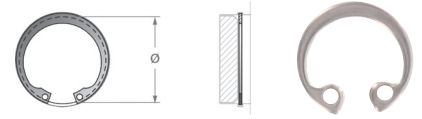

Ø (mm)	Boîlage	Code	Référence
8	200	CIRINT8A	V600-8204945
10	200	CIRINT10A	V600-8204944
11	200	CIRINT11A2	V600-8207400
12	200	CIRINT12A	V600-8204942
13	200	CIRINT13A2	V600-8207399
14	200	CIRINT14A	V600-8204940
15	200	CIRINT15A2	V600-8207398
16	200	CIRINT16A	V600-8204937
17	100	CIRINT17A2	V600-8207397
18	100	CIRINT18A	V600-8204935
19	100	CIRINT19A2	V600-8207396
20	100	CIRINT20A	V600-8204933
22	100	CIRINT22A	V600-8204929
24	100	CIRINT24A2	V600-8207395
26	50	CIRINT26A	V600-8204927
28	50	CIRINT28A	V600-8204928
29	50	CIRINT29A2	V600-8207394
30	50	CIRINT30A2	V600-8207393
31	25	CIRINT31A	V600-8204926
32	25	CIRINT32A2	V600-8207392
33	25	CIRINT33A2	V600-8207391
35	25	CIRINT35A2	V600-8207390
37	25	CIRINT37A2	V600-8207389

Ø (mm)	Boîlage	Code	Référence
38	25	CIRINT38A2	V600-8207388
39	25	CIRINT39A2	V600-8207387
40	25	CIRINT40A2	V600-8207386
41	25	CIRINT41A2	V600-8207385
42	25	CIRINT42A2	V600-8207384
43	25	CIRINT43A2	V600-8207383
45	25	CIRINT45A2	V600-8207382
47	25	CIRINT47A2	V600-8207381
48	25	CIRINT48A2	V600-8207380
50	25	CIRINT50A2	V600-8207379
52	25	CIRINT52A2	V600-8207378
58	25	CIRINT58A2	V600-8207377
60	25	CIRINT60A2	V600-8207376
62	10	CIRINT62A2	V600-8207375
65	10	CIRINT65A2	V600-8207374
68	10	CIRINT68A2	V600-8207373
70	10	CIRINT70A2	V600-8207372
72	10	CIRINT72A2	V600-8207371
75	10	CIRINT75A2	V600-8207370
80	10	CIRINT80A2	V600-8207369
85	10	CIRINT85A2	V600-8207368
90	10	CIRINT90A2	V600-8207367

Autres dimensions disponibles sur demande.

CIRCLIPS® EXTÉRIEUR A2

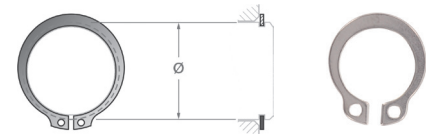

Ø (mm)	Boîlage	Code	Référence
4	200	CIREXT4A2	V600-8207449
5	200	CIREXT5A2	V600-8207448
6	200	CIREXT6A2	V600-8207447
8	200	CIREXT8A	V600-8204947
9	200	CIREXT9A2	V600-8207446
10	200	CIREXT10A	V600-8204946
11	200	CIREXT11A2	V600-8207421
12	200	CIREXT12A	V600-8204943
14	200	CIREXT14A	V600-8204941
15	200	CIREXT15A	V600-8204939
16	200	CIREXT16A	V600-8204938
17	100	CIREXT17A	V600-8204936
18	100	CIREXT18A	V600-8204934
19	100	CIREXT19A2	V600-8207420
20	100	CIREXT20A	V600-8204932
21	100	CIREXT21A2	V600-8207419
22	100	CIREXT22A	V600-8204931
23	100	CIREXT23A2	V600-8207418
24	100	CIREXT24A2	V600-8207417
26	50	CIREXT26A	V600-8204930
28	50	CIREXT28A2	V600-8207416
30	50	CIREXT30A	V600-8204925
32	50	CIREXT32A	V600-8204924
34	50	CIREXT34A2	V600-8207415

Ø (mm)	Boîlage	Code	Référence
35	50	CIREXT35A2	V600-8207414
36	25	CIREXT36A2	V600-8207413
38	25	CIREXT38A2	V600-8207412
40	25	CIREXT40A2	V600-8207411
42	25	CIREXT42A2	V600-8207410
45	25	CIREXT45A2	V600-8207409
50	25	CIREXT50A2	V600-8207408
55	25	CIREXT55A2	V600-8207407
60	25	CIREXT60A2	V600-8207406
65	10	CIREXT65A2	V600-8207405
70	10	CIREXT70A2	V600-8207404
75	10	CIREXT75A2	V600-8207403
80	10	CIREXT80A2	V600-8207402
85	10	CIREXT85A2	V600-8207401
100	10	CIREXT100A2	V600-8207337
105	10	CIRINT105A2	V600-8207331
110	10	CIREXT110A2	V600-8207336
115	5	CIREXT115A2	V600-8207335
125	5	CIREXT125A2	V600-8207334
140	5	CIREXT140A2	V600-8207333
150	5	CIREXT150A2	V600-8207332
125	5	CIRINT125A2	V600-8207330
150	5	CIRINT150A2	V600-8207329

Autres dimensions disponibles sur demande.



ÉCROU HEXAGONAL



DIN 934

Ø (mm)	Clé	Boîlage	Code	Référence
2	4	1000	ECHU2A4	V600-8207442
2,5	5	1000	ECHU2,5A4	V600-8207322

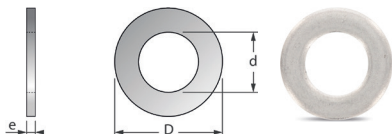

RONDELLE PLATE ÉTROITE A4



NFE 25-514

Ø	Dimensions (mm)	Boîlage	Code	Référence
Z2,5	5x2,7	500	RONZ2,5A4	V600-8206563
Z3	3,2x6x0,8	500	RONZ3A4	V600-8204954
Z4	4,3x8x0,8	500	RONZ4A4	V600-8204955
Z5	5,3x10x1	200	RONZ5A4	V600-8204953
Z6	6,4x12x1,2	200	RONZ6A4	V600-8204766
Z8	8,4x16x1,5	200	RONZ8A4	V600-8204767

Ø	Dimensions (mm)	Boîlage	Code	Référence
Z10	10,5x20x2	100	RONZ10A4	V600-8204765
Z12	13x24x2,5	100	RONZ12A4	V600-8204764
Z16	17x30x3	50	RONZ16A4	V600-8204763
Z18	19x32x3	50	RONZ18A4	V600-8204762
Z20	21x36x3	50	RONZ20A4	V600-8204760
Z22	40x23	25	RONZ22A4	V600-8206564

Autres dimensions disponibles sur demande.

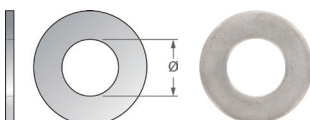

RONDELLE PLATE MOYENNE A4



NFE 25-514

Ø	Dimensions (mm)	Boîlage	Code	Référence
M2	5,5x2,2	500	RONMU2A4	V600-8206571
M2,5	7x2,7	500	RONMU2,5A4	V600-8206568
M3	3,2x8x0,8	500	RONMU3A4	V600-8204794
M4	10x4,3	500	RONMU4A4	V600-8206565
M5	5,3x12x1	200	RONMU5A4	V600-8204793
M6	6,4x14x1,2	200	RONMU6A4	V600-8204791
M8	8,4x18x1,5	200	RONMU8A4	V600-8204792
M10	10,5x22x2	100	RONMU10A4	V600-8204789
M12	13x27x2,5	100	RONMU12A4	V600-8204921

Ø	Dimensions (mm)	Boîlage	Code	Référence
M14	15x30x2,5	100	RONMU14A4	V600-8204790
M16	17x32x3	50	RONMU16A4	V600-8204788
M18	19x36x3	50	RONMU18A4	V600-8204787
M20	21x40x3	50	RONMU20A4	V600-8204786
M22	45x23	50	RONMU22A4	V600-8206570
M24	50x25	50	RONMU24A4	V600-8206569
M27	55x28	50	RONMU27A4	V600-8206567
M33	65x34	50	RONMU33A4	V600-8206589
M30	60x31	50	RONMU30A4	V600-8206566

Autres dimensions disponibles sur demande.

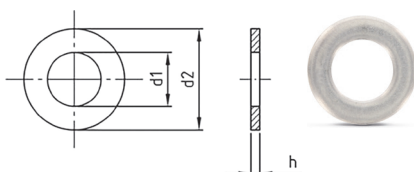

RONDELLE FORME A



DIN 125

Ø (mm)	Dimensions (mm)	Boîlage	Code	Référence
6,4	12x6,4	1000	RON6A4	V600-8207438

RONDELLE PLATE LARGE A4



DIN
9021

ISO
7093-1

NFE
25-514



Ø (mm)	Dimensions (mm)	Boîlage	Code	Référence
L3	9x3,2x0,8	1000	RONLU3A4DIN	V600-8207327
L4	14x4,3	500	RONLU4A4	V600-8206575
L5	15x5,3x1,2	1000	RONLU5A4DIN	V600-8207326
L6	18x6,4x1,8	1000	RONLU6A4DIN	V600-8207325

Ø (mm)	Dimensions (mm)	Boîlage	Code	Référence
L8	24x8,4x2	500	RONLU8A4DIN	V600-8207324
L10	30x10,5x2,5	500	RONLU10A4DIN	V600-8207319
L12	32x13	100	RONLU12A4	V600-8206577
L16	40x17	50	RONLU16A4	V600-8206576

RONDELLE ÉVENTAIL FORME A



DIN
6789A

Ø (mm)	Dimensions (mm)	Boîlage	Code	Référence
A10,5	18x10,5	1000	RONAZ10A4	V600-8207309

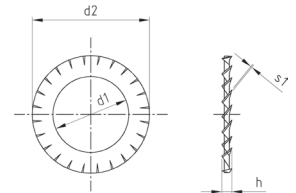

RONDELLE ÉLASTIQUE FORME B



DIN
127

Ø (mm)	Dimensions (mm)	Boîlage	Code	Référence
B3	1,6x1,3x6,2	1000	RONW3A4	V600-8207458
B4	1,8x1,5x7,6	1000	RONW4A4	V600-8207457
B5	2,4x1,8x9,2	1000	RONW5A4	V600-8207456
B6	3,2x2,5x11,8	1000	RONW6A4	V600-8207455
B8	4x3x14,8	1000	RONW8A4	V600-8207454

Ø (mm)	Dimensions (mm)	Boîlage	Code	Référence
B10	4,4x3,5x18,1	1000	RONW10A4	V600-8207432
B14	6x4,5x24,1	500	RONW14A4	V600-8207431
B18	7x5x29,4	250	RONW18A4	V600-8207430
B20	8x6x33,6	100	RONW20A4	V600-8207429

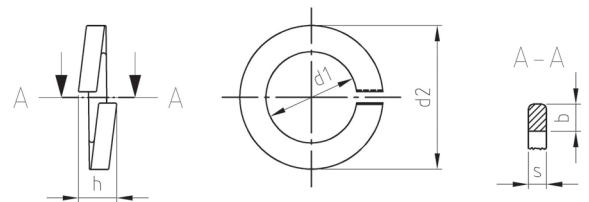

TIGE FILETÉE 1M A4



DIN
976

Ø (mm)	Longueur (mm)	Code	Référence
2	1000	TF1M2A2	V600-8206638
2	1000	TF1M2A4	V600-8206637
2,5	1000	TF1M2,5A4	V600-8207201
3	1000	TF1M3A4	V600-8204746
4	1000	TF1M4A4	V600-8204745
5	1000	TF1M5A4	V600-8204744
6	1000	TF1M6A4	V600-8204743
8	1000	TF1M8A4	V600-8204742
10	1000	TF1M10A4	V600-8204741
12	1000	TF1M12A4	V600-8204740

Ø (mm)	Longueur (mm)	Code	Référence
14	1000	TF1M14A4	V600-8204738
16	1000	TF1M16A4	V600-8204739
18	1000	TF1M18A4	V600-8204737
20	1000	TF1M20A4	V600-8204736
22	1000	TF1M22A4	V600-8207203
24	1000	TF1M24A4	V600-8207202
27	1000	TF1M27A4	V600-8207200
30	1000	TF1M30A4	V600-8204735
33	1000	TF1M33A4	V600-8207199
36	1000	TF1M36A4	V600-8207198



Autres dimensions disponibles sur demande.

TIGE FILETÉE 2M A4



DIN 976

Ø (mm)	Longueur (mm)	Code	Référence
6	2000	TF2M6A4	V600-8206636
8	2000	TF2M8A4	V600-8206635
12	2000	TF2M12A4	V600-8207205
20	2000	TF2M20A4	V600-8207204

VIS À TÊTE CYLINDRIQUE SIX PANS CREUX



DIN 912

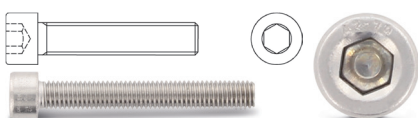

Dimensions ØxL (mm)	Filetage	Boîtage	Code	Référence
5x16	Total	500	CHC5X16EFA4	V600-8206893
5x25	Total	200	CHC5X25EFA4	V600-8206892
5x50	Total	200	CHC5X50EFA4	V600-8209236
6x20	Total	200	CHC6X20EFA4	V600-8206891
6x40	Total	200	CHC6X40EFA4	V600-8206890
8x20	Total	200	CHC8X20EFA4	V600-8206889
8x30	Total	100	CHC8X30EFA4	V600-8206888

Dimensions ØxL (mm)	Filetage	Boîtage	Code	Référence
10x30	Total	100	CHC10X30EFA4	V600-8206897
16x40	Total	25	CHC16X40EFA4	V600-8206894
3x30	Partiel	1000	CHC3X30PFA4	V600-8209250
8x60	Partiel	100	CHC8X60PFA4	V600-8206887
10x40	Partiel	100	CHC10X40PFA4	V600-8206896
10x80	Partiel	50	CHC10X80PFA4	V600-8206895

VIS TÊTE HEXAGONALE A4



DIN 933

DIN 931

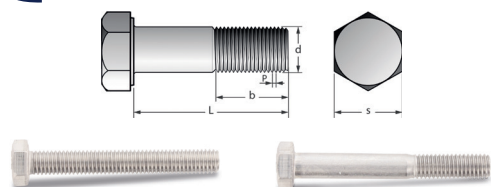

Dimensions ØxL (mm)	Filetage	Boîtage	Code	Référence
4x10	Total	500	TH4X10EFA4	V600-8209249
4x20	Total	500	TH4X20EFA4	V600-8209248
4x40	Total	500	TH4X40EFA4	V600-8209247
4x60	Total	500	TH4X60EFA4	V600-8209246
5x10	Total	500	TH5X10EFA4	V600-8209245
6x40	Total	200	TH6X40EFA4	V600-8209244
8x60	Total	100	TH8X60EFA4	V600-8209243
10x20	Total	100	TH10X20EFA4	V600-8206787
10x25	Total	100	TH10X25EFA4	V600-8206786
10x30	Total	100	TH10X30EFA4	V600-8206785
10x40	Total	100	TH10X40EFA4	V600-8206784
10x50	Total	50	TH10X50EFA4	V600-8206783
10x60	Total	50	TH10X60EFA4	V600-8206782
12x30	Total	50	TH12X30EFA4	V600-8206781
12x35	Total	50	TH12X35EFA4	V600-8206780
12x40	Total	50	TH12X40EFA4	V600-8206779
12x50	Total	50	TH12X50EFA4	V600-8206778

Dimensions ØxL (mm)	Filetage	Boîtage	Code	Référence
12x120	Total	25	TH12X120EFA4	V600-8209241
14x50	Total	50	TH14X50EFA4	V600-8206777
14x60	Total	50	TH14X60EFA4	V600-8206776
16x70	Total	25	TH16X70EFA4	V600-8206775
16x80	Total	25	TH16X80EFA4	V600-8209212
18x60	Total	25	TH18X60EFA4	V600-8206774
5x16	Total	500	TH5X16EFA4	V600-8206773
6x16	Total	200	TH6X16EFA4	V600-8206772
6x30	Total	200	TH6X30EFA4	V600-8206771
6x50	Total	100	TH6X50EFA4	V600-8206770
8x25	Total	100	TH8X25EFA4	V600-8206769
8x40	Total	100	TH8X40EFA4	V600-8206768
10x40	Partiel	100	TH10X40PFA4	V600-8209242
12x150	Partiel	25	TH12X150PFA4	V600-8209240
16x70	Partiel	25	TH16X70PFA4	V600-8206845
16x90	Partiel	25	TH16X90PFA4	V600-8209211

VIS POELIER TLR FENDUE A4



Dimensions ØxL (mm)	Filetage	Boîtage	Code	Référence
5x25	Total	500	VMTRL5X25A4	V600-8206590

VIS À TÊTE FRAISÉE À EMPREINTE CRUCIFORME PZ A4



Dimensions ØxL (mm)	Filetage	Boîtage	Code	Référence
5x10	Total	500	VTFPOZ5X10A4	V600-8206642
5x8	Total	500	VTFPOZ5X8A4	V600-8206641
6x16	Total	500	VTFPOZ6X16A4	V600-8206640

VIS À TÊTE FRAISÉE HC



Dimensions ØxL (mm)	Filetage	Boîtage	Code	Référence
4x30	Total	500	FHC4X30EFA4ISO	V600-8206616
6x12	Total	500	FHC6X12EFA4ISO	V600-8206615
6x30	Total	200	FHC6X30EFA4ISO	V600-8206614

VIS À TÊTE FRAISÉE FENDUE A4



Dimensions ØxL (mm)	Filetage	Boîtage	Code	Référence
5x12	Total	500	VTFFDU5X12EFA4	V600-8206693
6x30	Total	200	VTFFDU6X30EFA4	V600-8206692

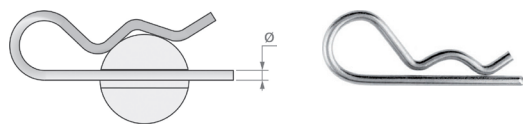

GROUPILLE BETA



Ø (mm)	Boîlage	Code	Référence
2	50	GOBETA2A4	V600-8204855
2,5	50	GOBETA2,5A4	V600-8204854

Ø (mm)	Boîlage	Code	Référence
3	50	GOBETA3A4	V600-8204852
4	20	GOBETA4A4	V600-8204853

Autres dimensions disponibles sur demande.



GROUPILLE CYLINDRIQUE FENDUE A4



Dimensions ØxL (mm)	Boîlage	Code	Référence
1X8	1000	GOFDU1X8A4	V600-8207095
1X10	1000	GOFDU1X10A4	V600-8207099
1X16	1000	GOFDU1X16A4	V600-8207098
1X18	1000	GOFDU1X18A4	V600-8207097
1X20	1000	GOFDU1X20A4	V600-8207096
1,2X20	1000	GOFDU1,2X20A4	V600-8207094
1,6X10	1000	GOFDU1,6X10A4	V600-8207093
1,6X12	1000	GOFDU1,6X12A4	V600-8207092
1,6X16	1000	GOFDU1,6X16A4	V600-8207091
1,6X20	1000	GOFDU1,6X20A4	V600-8207090
1,6X22	1000	GOFDU1,6X22A4	V600-8207089
1,6X25	1000	GOFDU1,6X25A4	V600-8207088
1,6X32	1000	GOFDU1,6X32A4	V600-8207087
2X16	1000	GOFDU2X16A4	V600-8207086
2X20	1000	GOFDU2X20A4	V600-8207085
2X25	1000	GOFDU2X25A4	V600-8207084
2X32	1000	GOFDU2X32A4	V600-8207083
2X36	1000	GOFDU2X36A4	V600-8207082
2X40	1000	GOFDU2X40A4	V600-8207081
2,5X12	1000	GOFDU2,5X12A4	V600-8207080
2,5X16	1000	GOFDU2,5X16A4	V600-8207079
2,5X20	1000	GOFDU2,5X20A4	V600-8207078
2,5X22	1000	GOFDU2,5X22A4	V600-8207077
2,5X28	1000	GOFDU2,5X28A4	V600-8207076
2,5X32	1000	GOFDU2,5X32A4	V600-8207075
2,5X36	1000	GOFDU2,5X36A4	V600-8207074
2,5X40	1000	GOFDU2,5X40A4	V600-8207073
2,5X45	1000	GOFDU2,5X45A4	V600-8207072
2,5X50	1000	GOFDU2,5X50A4	V600-8207071
3,2X20	500	GOFDU3,2X20A4	V600-8207070
3,2X22	500	GOFDU3,2X22A4	V600-8207069
3,2X25	500	GOFDU3,2X25A4	V600-8207068
3,2X28	500	GOFDU3,2X28A4	V600-8207067
3,2X32	500	GOFDU3,2X32A4	V600-8207066

Dimensions ØxL (mm)	Boîlage	Code	Référence
3,2X36	500	GOFDU3,2X36A4	V600-8207065
3,2X40	500	GOFDU3,2X40A4	V600-8207064
3,2X45	500	GOFDU3,2X45A4	V600-8207063
3,2X50	500	GOFDU3,2X50A4	V600-8207062
3,2X56	500	GOFDU3,2X56A4	V600-8207061
4X20	500	GOFDU4X20A4	V600-8207060
4X22	500	GOFDU4X22A4	V600-8207059
4X25	500	GOFDU4X25A4	V600-8207058
4X32	500	GOFDU4X32A4	V600-8207057
4X36	500	GOFDU4X36A4	V600-8207056
4X40	500	GOFDU4X40A4	V600-8207055
4X50	500	GOFDU4X50A4	V600-8207054
4X56	500	GOFDU4X56A4	V600-8207053
4X63	500	GOFDU4X63A4	V600-8207052
4X80	500	GOFDU4X80A4	V600-8207051
5X32	250	GOFDU5X32A4	V600-8207050
5X36	250	GOFDU5X36A4	V600-8207049
5X40	250	GOFDU5X40A4	V600-8207048
5X45	250	GOFDU5X45A4	V600-8207047
5X50	250	GOFDU5X50A4	V600-8207046
5X63	250	GOFDU5X63A4	V600-8207045
5X80	250	GOFDU5X80A4	V600-8207044
6,3X32	250	GOFDU6,3X32A4	V600-8207043
6,3X40	250	GOFDU6,3X40A4	V600-8207042
6,3X50	250	GOFDU6,3X50A4	V600-8207041
6,3X63	250	GOFDU6,3X63A4	V600-8207040
6,3X80	250	GOFDU6,3X80A4	V600-8207039
8X40	100	GOFDU8X40A4	V600-8207038
8X50	100	GOFDU8X50A4	V600-8207037
8X63	100	GOFDU8X63A4	V600-8207036
8X80	100	GOFDU8X80A4	V600-8207035
8X90	100	GOFDU8X90A4	V600-8207034
8X100	100	GOFDU8X100A4	V600-82070318
10X100	100	GOFDU10X100A4	V600-8207211

RONDELLE PLATE PA 6.6



Ø	Dimensions (mm)	Boîlage	Code	Référence
M3	3,2x8x0,8	200	RON3PA6	V600-8203960
M4	4,3x10x0,8	200	RON4PA6	V600-8203959
M5	5,3x12x1	200	RON5PA6	V600-8203958

Ø	Dimensions (mm)	Boîlage	Code	Référence
M6	6,4x14x1,2	200	RON6PA6	V600-8203957
M8	8,4x18x1,5	200	RON8PA6	V600-8203956

Autres dimensions disponibles sur demande.

VISSERIE-BOULONNERIE LAITON

ÉCROU HEXAGONAL LAITON CU2/CU3

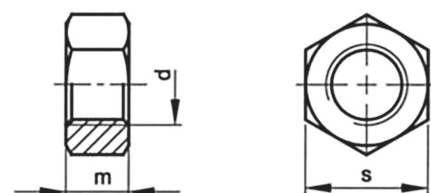

Ø (mm)	Dimensions (mm)	Boîlage	Code	Référence
M2,5	2x0,45x5	250	ECHU2,5LT	V600-8205288
M4	3,2x0,70x7	250	ECHU4LT	V600-8205287
M5	4x0,80x8	250	ECHU5LT	V600-8205286
M8	6,5x1,25x13	250	ECHU8LT	V600-8205285

Ø (mm)	Dimensions (mm)	Boîlage	Code	Référence
M10	8x1,50x17	100	ECHU10LT	V600-8205284
M12	10x1,75x19	50	ECHU12LT	V600-8205283
M16	13x2x24	25	ECHU16LT	V600-8205282
M20	16x2,50x30	10	ECHU20LT	V600-8205281

ÉCROU À OREILLES ARRONDIES LAITON CU2/CU3

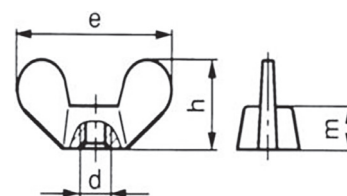

Ø (mm)	Dimensions (mm)	Boîlage	Code	Référence
M4	20x10,5x3,2	250	ECOR4LT	V600-8205280
M5	26x13x4	250	ECOR5LT	V600-8205279
M6	33x17x5x1	200	ECOR6LT	V600-8205278
M8	39x20x6,5	100	ECOR8LT	V600-8205277

Ø (mm)	Dimensions (mm)	Boîlage	Code	Référence
M10	51x25x8	100	ECOR10LT	V600-8205276
M12	65x33,5x10	50	ECOR12LT	V600-8205275
M14	65x33,5x11,2	50	ECOR14LT	V600-8205274
M16	73x37,5x13	20	ECOR16LT	V600-8205273

Désignation	Page
Boulon	24
Circlips®	41-42, 65
Écrou.....	6, 27-28, 43, 66, 71
Écrou à oreilles.....	6, 44, 71
Écrou borgne	6, 44
Écrou frein bague	7
Écrou frein bague nylon	43
Goupille	25, 41, 64, 70
Rondelle	7-8, 28, 44-47, 66-67, 71
Rondelle carrossier	10
Rondelle de contact	9-10
Rondelle éventail	8-9, 46, 67
Rondelle grower	9, 46, 67
Rondelle ondulée	10
Tige filetée.....	10-11, 29, 47, 67-68
Vis aggloméré	17, 20, 26, 55

Désignation	Page
Vis autoperceuse cylindrique.....	21
Vis autoperceuse fraisée	21
Vis autoperceuse hexagonale.....	20
Vis CHC.....	29, 52-53
Vis FHC	54
Vis poêlier	22, 55, 59, 69
Vis pour plaque	40
Vis sans tête.....	23, 39, 59-60
Vis STHC.....	30-31, 51
Vis tête à oreilles	57
Vis tête bombée	57, 61, 63
Vis tête cylindrique	14-16, 20, 35, 37, 40, 56, 68
Vis tête fraisée.....	17-19, 26, 38, 40, 58, 60, 62, 69
Vis tête hexagonale	11, 26, 32, 34, 48, 68
Vis tête ronde.....	23, 63
Vis tirefond.....	22, 56



Conditions générales de vente rubix engineering («rubix»)

Ce catalogue annule et remplace toutes les éditions précédentes. Catalogue réservé aux professionnels. Toutes les reproductions, mêmes partielles, ne peuvent avoir lieu qu'avec notre accord écrit et préalable. RUBIX ENGINEERING se réserve le droit de modifier tout ou partie de ses gammes de produits. Informations techniques modifiables sans préavis. Les conseils de sécurité et d'usage de RUBIX ENGINEERING ne se substituent pas aux règles

professionnelles et nationales établies. Fiches de données de sécurité des produits soumis à la réglementation, disponibles sur simple demande. Les performances indiquées sont celles obtenues au cours des tests. Elles sont non contractuelles. Les conditions générales de vente applicables sont disponibles sur simple demande auprès de votre distributeur agréé RUBIX. Dans la limite des stocks disponibles. Photos non contractuelles. Sauf erreurs typographiques.

A series of horizontal dotted lines spaced evenly down the page, providing a guide for handwriting or text entry.

A series of horizontal dotted lines for writing notes, spanning the width of the page.

MARQUES EXCLUSIVES RUBIX

EFFICACITÉ. DISPONIBILITÉ. FIABILITÉ



FIERS DE NOS MARQUES !

➤ Plus de 10 000 usines françaises font confiance à nos produits dédiés à la performance industrielle.

GISS

MAINTENANCE & EPI

Roebuck

OUTILLAGE INDUSTRIEL

GISS CUTLINE

USINAGE PRODUCTION

MECALINE

TRANSMISSION PUISSANCE

Anfitec

VISSERIE BOULONNERIE

Q-SAFE

ALTERNATIVE EPI



 Anfitec

31, RUE DE LA BAUME - 75008 - PARIS - FRANCE
811 979 459 R.C.S. PARIS



www.rubix-engineering.com